

DOBRADIÇAS  
BISAGRAS  
HINGES  
PAUMELLES

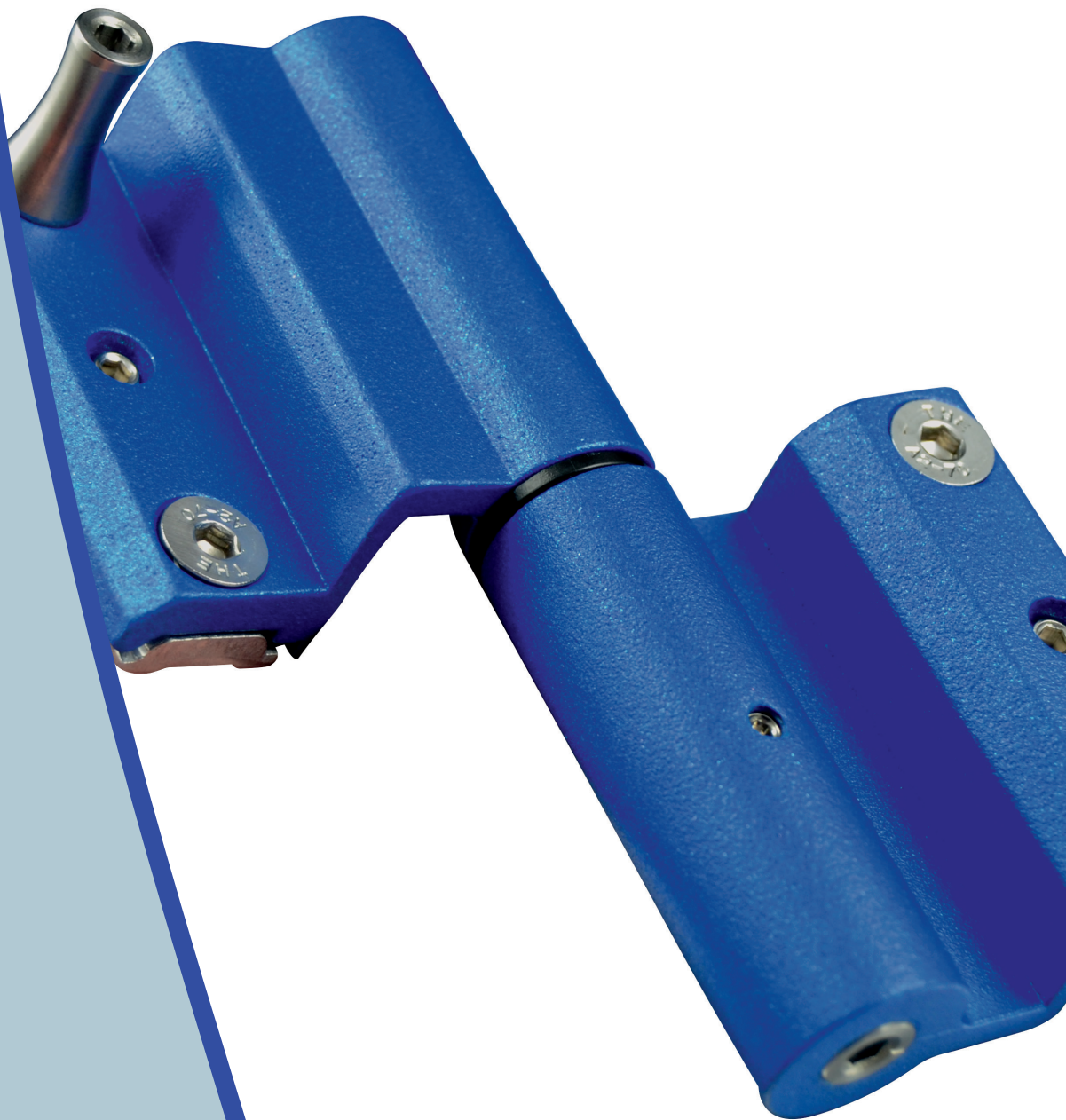

6



# ÍNDICE

DOBRADIÇAS  
BISAGRAS  
HINGES  
PAUMELLES

FUTURA 8100	04	VULCANA 2P T-SPEC	13
FUTURA 8100		VULCANA 2P T-SPEC	
FUTURA 8100		VULCANA 2P T-SPEC	
FUTURA 8100		VULCANA 2P T-SPEC	
FUTURA 7100	05	VULCANA 2P T-SPEC 2	14
FUTURA 7100		VULCANA 2P T-SPEC 2	
FUTURA 7100		VULCANA 2P T-SPEC 2	
FUTURA 7100		VULCANA 2P T-SPEC 2	
FUTURA 8100 SPEC	06	VULCANA 3P	15
FUTURA 8100 SPEC		VULCANA 3P	
FUTURA 8100 SPEC		VULCANA 3P	
FUTURA 8100 SPEC		VULCANA 3P	
FUTURA 8100 T-SPEC	07	VULCANA 3P T-SPEC	16
FUTURA 8100 T-SPEC		VULCANA 3P T-SPEC	
FUTURA 8100 T-SPEC		VULCANA 3P T-SPEC	
FUTURA 8100 T-SPEC		VULCANA 3P T-SPEC	
FUTURA 2P	08	VULCANA 3P SPEC	17
FUTURA 2P		VULCANA 3P SPEC	
FUTURA 2P		VULCANA 3P SPEC	
FUTURA 2P		VULCANA 3P SPEC	
FUTURA 2P SPEC	09	VULCANA 2P SPEC	17
FUTURA 2P SPEC		VULCANA 2P SPEC	
FUTURA 2P SPEC		VULCANA 2P SPEC	
FUTURA 2P SPEC		VULCANA 2P SPEC	
FUTURA 2P T-SPEC 2	10	SÉRIE A7 / VEDA LUZ	18-19
FUTURA 2P T-SPEC 2		SÉRIE A7 / VEDA LUZ	
FUTURA 2P T-SPEC 2		A7 SERIE / WINDOW HINGES	
FUTURA 2P T-SPEC 2		SÉRIE A7 / PAUMELLES POUR FENÊTRES	
FUTURA 2P T-SPEC	11	DOBRADIÇAS ALUMÍNIO	20
FUTURA 2P T-SPEC		BISAGRAS ALUMINIO	
FUTURA 2P T-SPEC		ALUMINIUM HINGES	
FUTURA 2P T-SPEC		PAUMELLES EN ALUMINIUM	
VULCANA 2P	12	ABERTURA BASCULANTE	21
VULCANA 2P		APERTURA BASCULANTE	
VULCANA 2P		SWINGING OPENING	
VULCANA 2P		OVERTURE BASCULANT	

# SUMÁRIO ICONES

ICONES  
ICONOS  
ICONS  
ICÔNES

## EMBALAGENS - ENVASES - PACKAGING - EMBALLAGES

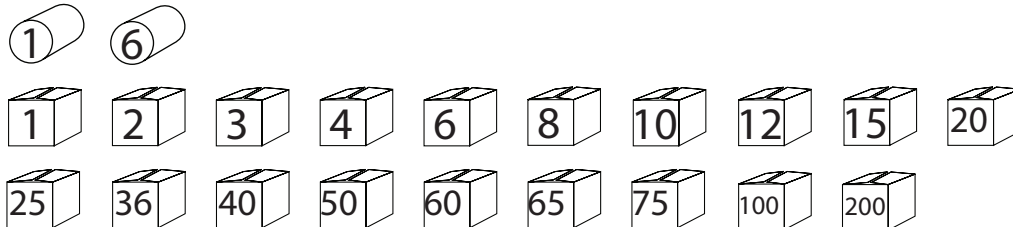

## MATERIAIS - MATERIALES - MATERIALS - MATÉRIELS



## ACABAMENTOS - ACABADOS - FINISHINGS - FINITIONS





## CORES - COLORES - COLOURS - COLEURS





COR POR ENCOMENDA - COLOR POR ENCARGO - COLOR BY REQUEST - COLEUR PAR COMMANDE

 Refs. 6200 mate (verde 61) - 6192 (verde 62) - 6005 - 6005 (mate) - 6009

 Refs. 1013 - 1015 - 1015(mate)

 Refs. 8014 - 8017 - 8146 - 8146 (mate)

 Refs. 7011 - 7012 - 7035 (mate) - 7040 - 7042 - 7048 - 9002 - 9006

 Refs. 9001 - 9003 - 9010 - 9110 (mate)

 Refs. 3003 - 3005

 Refs. 5010 - 5013

 Refs. 1011



# SUMÁRIO ICONES

ICONES  
ICONOS  
ICONS  
ICÔNES

## MEDIDAS - MEDIDAS - SIZES - MESURES



- Distância do meio do cilindro à frente da fechadura.
- Distancia desde el medio del cilindro al frente de la cerradura.
- Distance from the middle of the cylinder to the lock front plate.
- Distance à du milieu du cylindre jusqu'au têtierre.



- Distância do meio do quadrado até o centro do cilindro.
- Distancia desde el medio del cuadradillo hasta el centro del cilindro.
- Distance from the middle of the square to the middle of cylinder.
- Distance du milieu du carré jusqu'au milieu du cylindre.



- Testa lisa / testa U
- Frente plano / frente U
- Flat shape / U shape
- Têtierre plate / têtierre u

## REGULAÇÃO - REGULACIÓN - REGULATION - RÉGLAGE



## CONCEITOS - CONCEPTOS - CONCEPTS - CONCEPTS



Instalação rápida da dobradiça no perfil - Instalación rápida de la bisagra en el canal  
Easy installation in the profiles - Instalation facile de la paumelle dans le profil



Caixas estreitas para perfis de corte térmico - Cajas estrechas para perfiles de corte térmico  
Narrow boxes for thermal break profiles - Boîtes étroites pour profilés à rupture thermique



Flexibilidade/ facilidade na permuta de trinco para rolete ou viceversa  
Flexibilidad / facilidad en la permuta del picaporte para rodillo y viceversa  
Flexibility / facility on the the swap latch to the roller and vice versa  
Flexibilité / facilité au chagement entre demi-tour et rouleau

As imagens contidas neste catálogo, destinam-se à promoção dos produtos e fruto do seu constante desenvolvimento, podem não reflectir a forma como num dado momento, um produto é fornecido ou embalado, pelo que por si não constituem uma obrigação legal. Antes de cada encomenda é sempre necessário confirmar o seu estado actual.

Las imágenes mostradas en este catálogo se destinan a la promoción de sus productos y fruto de su constante desarrollo pueden no reflejar la forma en como en un momento dado, el producto puede ser distribuido o embalado, de modo que por si, no constituyen una obligación legal. Antes de cada pedido será necesario confirmar su estado actual.

The images in this catalogue are intended to promote the product and by its constant development, may not reflect the way a product is being delivered or packaged, so by themselves they do not constitute a legal obligation. Before each order it is always necessary to confirm its current status.

Les images de ce catalogue se destinent à la promotion des produits et elles ne constituent pas une obligation contractuelle de la façon dont les produits sont finalement fabriqués, emballés ou vendus. Avant une commande ils faut toujours vérifier sont stade actuelle.

## DOBRADIÇAS

# DOBRADIÇA FUTURA 8100

BISAGRA PARA PUERTA  
DOOR HINGE  
PAUMELLE DE PORTE

# FUTURA



■ Dobradiça em alumínio para séries de câmara europeia.  
Desenvolvida para suportar cargas elevadas.  
Fiel em inox 304 e perno central de segurança.  
Regulação 2D.

■ Bisagra en aluminio para series de canal europeo.  
Desarrollada para soportar cargas elevadas.  
Eje en inox 304 y perno central de seguridad.  
Regulación 2D.

■ Aluminium hinge for european groove aluminium profiles.  
Developed to support heavy weight.  
304 stainless steel axis and central grub screw.  
2D regulation system.

■ Paumelle en aluminium pour gorge européenne.  
Conçu pour résister à des charges élevés.  
Axe en acier inoxydable 304.  
Réglage 2D.

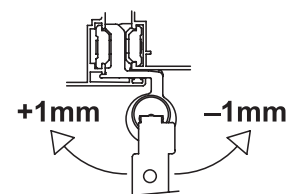
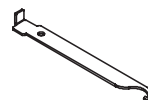
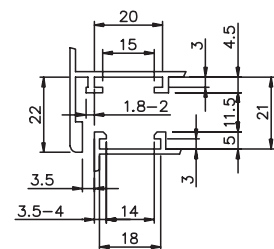
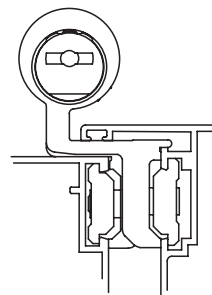
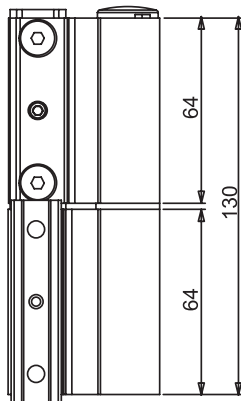
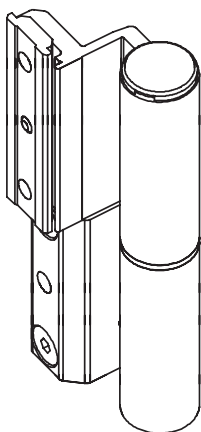
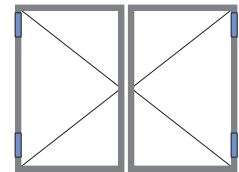
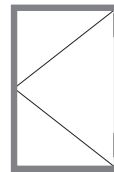

# FUTURA

## DOBRADIÇAS DOBRADIÇA FUTURA 7100

BISAGRA PARA PUERTA  
DOOR HINGE  
PAUMELLE DE PORTE



■ Dobradiça em alumínio para séries de câmara europeia.  
Desenvolvida para suportar cargas elevadas.  
Fiel excêntrico em inox 304.  
**Regulação 3D.**

■ Bisagra en aluminio para canal europeo.  
Desarrollada para soportar cargas elevadas.  
Eje descentrado en inox 304.  
**Regulación 3D.**

■ Aluminium hinge for european groove.  
Developed to support heavy weight.  
Eccentric axis in 304 stainless steel pin.  
**3D regulation system.**

■ Paumelle en aluminium pour gorge européenne.  
Conçu pour résister à des charges élevés.  
Axe excentrique en inox 304.  
**Réglage 3D.**

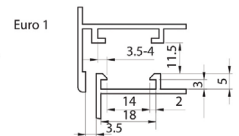
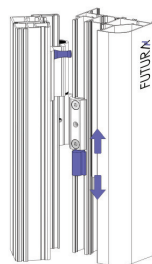
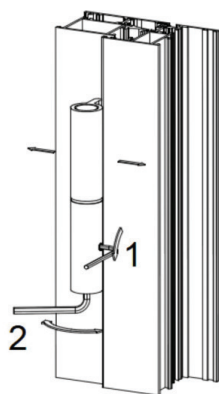
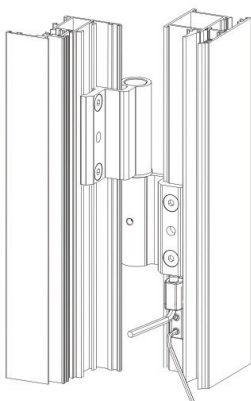
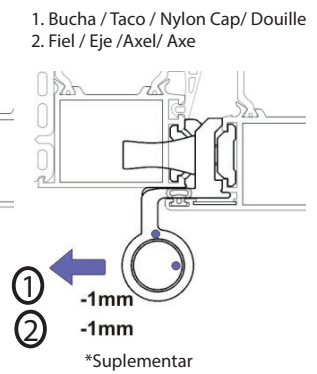
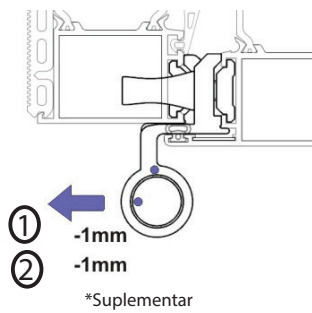
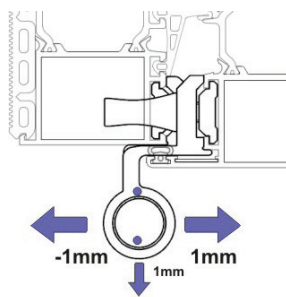
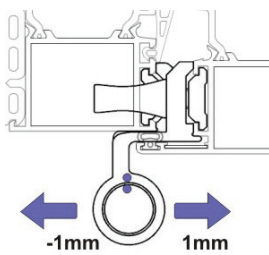
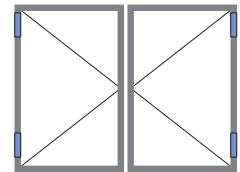
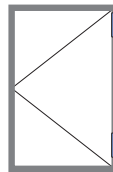

## DOBRADIÇAS

# DOBRADIÇA FUTURA 8100 SPEC

BISAGRA PARA PUERTA  
DOOR HINGE  
PAUMELLE DE PORTE

# FUTURA



■ Dobradiça em alumínio para perfis de alumínio de câmara europeia. Dobradiça de 3 corpos, desenvolvida para assegurar a mais elevada performance aos mais exigentes requisitos.  
Fiel em 304 e perno de segurança, permite regulação a 2D.

■ Bisagra en aluminio para perfiles de aluminio de canal europeo. Bisagra de 3 cuerpos desarrollada para asegurar la mejor respuesta a los requisitos más exigentes.  
Eje en acero inoxidable 304, perno de seguridad. Permite regulación 2D.

■ Aluminium hinge for european groove aluminium profiles. 3 body aluminium hinge, specially developed to ensure the best performance in the most demanding situations. 304 stainless steel axis and security pin. 2D regulation system.

■ Paumelle en aluminium pour profils de gorge européenne.  
3 lames, développé pour garantir la plus haute performance pour les applications les plus exigeantes. Axe en inox 304. Système de réglage 2D.

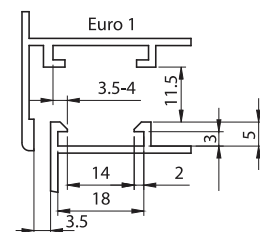
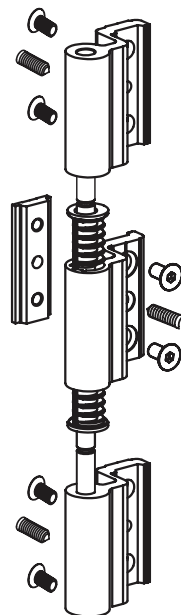
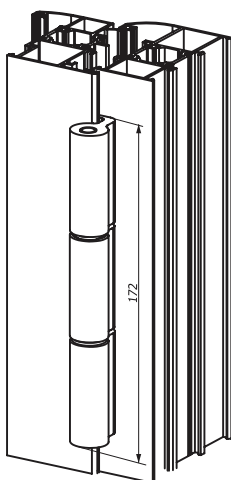
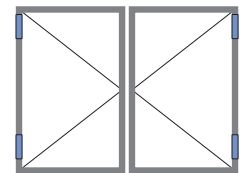
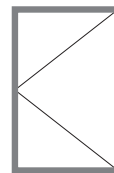



# FUTURA

## DOBRADIÇAS DOBRADIÇA FUTURA 8100 T-SPEC

BISAGRA PARA PUERTA  
DOOR HINGE  
PAUMELLE DE PORTE



- Dobradiça em alumínio para perfis de alumínio de câmara europeia. Dobradiça tripla desenvolvida para assegurar a mais elevada performance aos mais exigentes requisitos.  
Fiel em inox 304, perno de segurança. Regulação 2D.
- Bisagra en aluminio para perfiles de aluminio de canal europeo. Bisagra triple.  
Desarrollada para soportar cargas elevadas.  
Eje en inox 304, perno de seguridad.  
Permite regulación 2D.
- Aluminium hinge for european groove aluminium profiles. Triple shape aluminium hinge, specially developed to ensure the best performance in the most demanding situations.  
304 stainless steel axis and security pin. 2D regulation.
- Paumelle en aluminium pour gorge européenne. 3 lames en aluminium.  
Developpé pour garantir la plus haute performance pour les applications les plus exigeantes.  
Axe en inox 304. Système de réglage 2D.

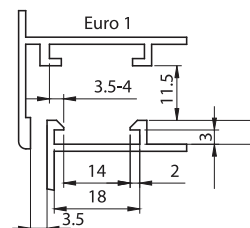
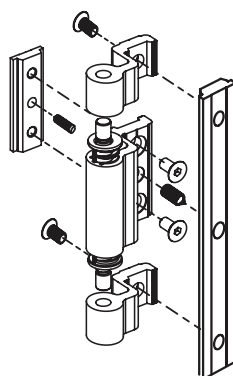
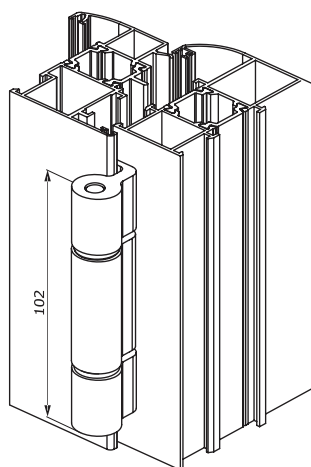
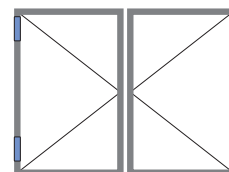
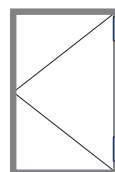

6

AL

ANODIZED

LACQ

2 REG D

# DOBRADIÇAS DOBRADIÇA FUTURA 2P

BISAGRA  
HINGE  
PAUMELLE

# FUTURA



- Dobradiça em alumínio para perfis em alumínio de canal europeu.  
Com os sistema EZ-FIT permite rápida instalação no perfil. **Disponível com ou sem regulação.**  
Fiel em inox. Os calços apresentam um dente especial para evitar o deslizamento.
- Bisagra en aluminio para perfiles de canal europeo.  
Con el sistema EZ-FIT permite una rápida instalación en el perfil. **Disponible con o sin regulación.**  
Eje en inox. Las contrachapas presentan un dente especial para evitar el deslizamiento.
- Aluminium hinge for european groove aluminium profiles. With the EZ-FIT system, that allows an easy installation in the profiles. **Available with or without regulation.**  
Stainless steel axis. The back plates are incorporated with a special serration in order to avoid slipping.
- Paumelle en aluminium pour aluminium profiles de gorge europeenne. Avec le système EZ-FIT, qui permet une installation rapide et facile de la paumelle dans le profil. **Disponible avec ou sans régulation.**  
Axe en acier inox. Les platines incorporent un denté spécial pour éviter le glissement.

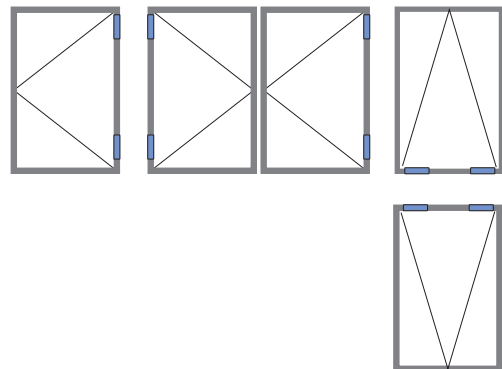

**EZ FIT**  
FAST AND EASY TO INSTALL

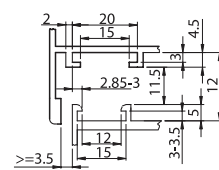
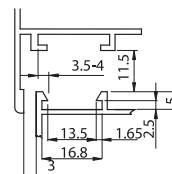
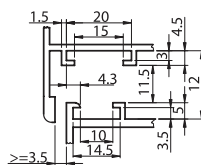
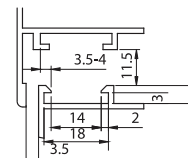
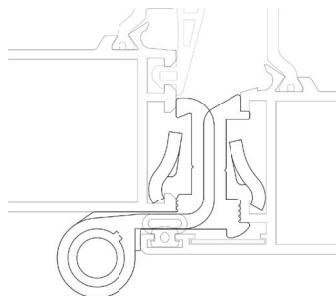
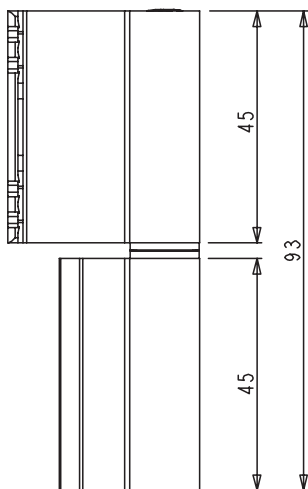

50

AL

ANODIZED

LACQ

2 REG D

\*Aplicável em canais de 10 / 12 / 13,5 / 14  
\*Aplicable en canales de 10 / 12 / 13,5 / 14  
\*Applicable in 10 / 12 / 13,5 / 14 grooves  
\*Applicable dans les gorges de 10 / 12 / 13,5 / 14

# FUTURA

## DOBRADIÇAS DOBRADIÇA FUTURA 2P SPEC

BISAGRA  
HINGE  
PAUMELLE



- Dobradiça em alumínio para perfis em alumínio de canal europeu. Suporta cargas elevadas. Com os sistema EZ-FIT permite rápida instalação no perfil. Fiel em inox. Os calços apresentam um dentado especial para evitar o deslizamento.
- Bisagra en aluminio para perfiles de canal europeo. Con el sistema EZ-FIT permite una rápida instalación en el perfil. Soporta cargas elevadas. Eje en inox. Las contrachapas presentan un dentado especial para evitar el deslizamiento.
- Aluminium hinge for european groove aluminium profiles. With the EZ-FIT system, that allows an easy installation in the profiles. Developed for heavy-duty work. Stainless steel axis. The back plates are incorporated with a special serration in order to avoid slipping.
- Paumelle en aluminium pour aluminium profiles de gorge europeenne- Avec le système EZ-FIT, qui permet une installation rapide et facile de la paumelle dans le profil. Developé pour suporté charges élevés. Axe en acier inox. Les platines incorporent un denté spécial pour éviter le glissement.

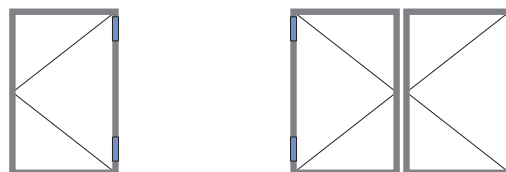

**EZ FIT**  
FAST AND EASY TO INSTALL

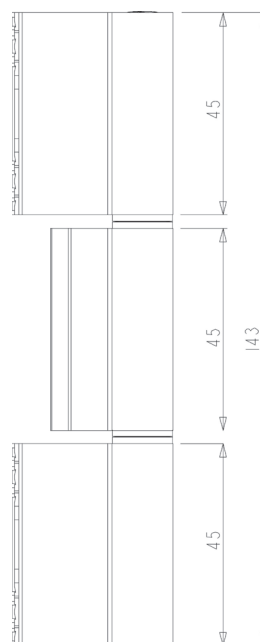
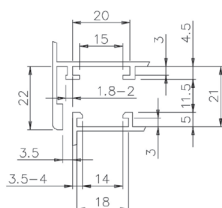

8

AL

ANODIZED

LACQ

2 REG D

## DOBRADIÇAS

# DOBRADIÇA FUTURA 2P T-SPEC 2

BISAGRA  
HINGE  
PAUMELLE

# FUTURA



■ Dobradiça em alumínio para perfis em alumínio de canal europeu. Recomendada para uso em forças transversais. Desenvolvida para suportar cargas elevadas. Fiel em inox 304.

Sistema EZ-FIT para uma instalação rápida e fácil no perfil. Os calços apresentam um dentado especial para evitar o deslizamento.

■ Bisagra en aluminio para perfiles en aluminio de canal europeo. Desarrollada para soportar cargas elevadas. Eje en acero inox 304.

Sistema EZ-FIT para una instalación rápida en el perfil. Las contrachapas presentan un dentado especial para evitar el deslizamiento.

■ Aluminium hinge for european groove aluminium profiles. Developed for heavy-duty work. Axis in stainless steel 304. Recommended for where there are large transversal forces.

EZ-FIT system for an easy installation in the profile. The back plates are incorporated with a special serration in order to avoid slipping.

■ Paumelle en aluminium pour aluminium profiles de gorge européenne.

Recommandé quand il a grands efforts transversaux. Développé pour supporté charges élevées.

Avec le systemme EZ-FIT, qui permet une installation rapide et facile de la paumelle dans le profil.

Axe en acier inox 304.

Les platines incorporent un denté spécial pour éviter le glissement.

**EZ FIT**  
FAST AND EASY TO INSTALL

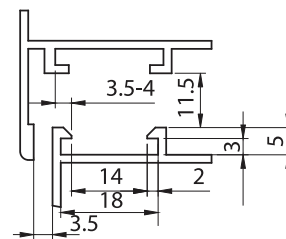
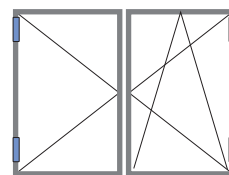
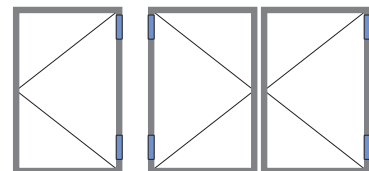
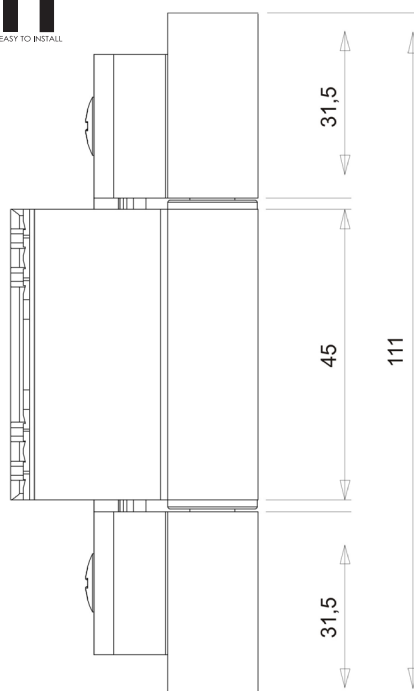

50

AL

ANODIZED

LACQ

# DOBRADIÇA FUTURA 2P T-SPEC

DOBRADIÇAS

FUTURA

BISAGRA  
HINGE  
PAUMELLE



■ Dobradiça em alumínio para perfis em alumínio de canal europeu. Recomendada para uso em forças transversais. Desenvolvida para suportar cargas elevadas.

Fiel em inox 304.

Sistema EZ-FIT para uma instalação rápida e fácil no perfil. Os calços apresentam um dentado especial para evitar o deslizamento.

■ Bisagra en aluminio para perfiles en aluminio de canal europeo. Desarrollada para soportar cargas elevadas.

Eje en acero inox 304.

Sistema EZ-FIT para una instalación rápida en el perfil. Las contrachapas presentan un dentado especial para evitar el deslizamiento.

■ Aluminium hinge for european groove aluminium profiles. Developed for heavy-duty work. Axis in stainless steel 304. Recommended for where there are large transversal forces.

EZ-FIT system for an easy installation in the profile.

The back plates are incorporated with a special serration in order to avoid slipping.

■ Paumelle an aluminium pour aluminium profiles de gorge européenne.

Recommandé quand il a grands efforts transversaux.

Developé pour supporté charges élevées.

Avec le systemme EZ-FIT, qui permit une instalation rapide et facile de la paumelle dans le profil.

Axe en acier inox 304.

Les platines incorporent un denté spécial pour éviter le glissement.

**EZ FIT**  
FAST AND EASY TO INSTALL

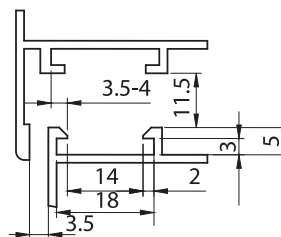
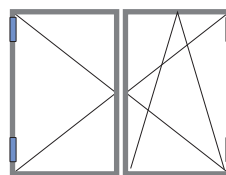
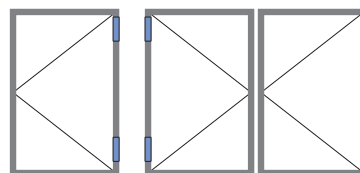
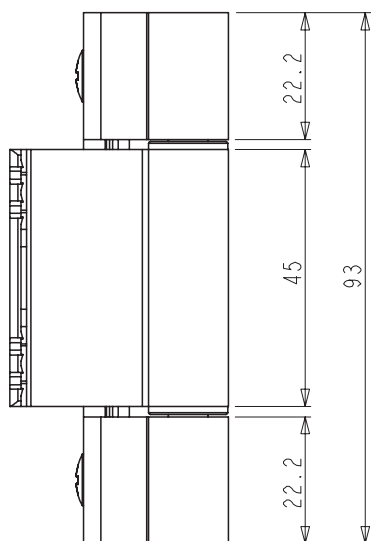

50

AL

ANODIZED

LACQ

# DOBRADIÇAS

## DOBRADIÇA VULCANA 2P

BISAGRA  
HINGE  
PAUMELLE

VULCANA



- Dobradiça em alumínio para perfis em alumínio de canal europeu.  
Com regulação e fiel em Inox.  
Os calços apresentam um dentado especial para evitar o deslizamento.
- Bisagra en aluminio para perfiles en aluminio de canal europeo.  
Regulable y con eje en acero inoxidable.  
Las contrachapas presentan un dentado especial para evitar el deslizamiento.
- Aluminium hinge for european groove aluminium profiles.  
With regulation and stainless steel axis.  
The back plates are incorporated with a special serration in order to avoid slipping.
- Paumelle en aluminium pour aluminium profiles de gorge europeenne.  
Reglable et avec ax en acier inoxydable.  
Les platines incorporent un denté spécil pour éviter le glissement.

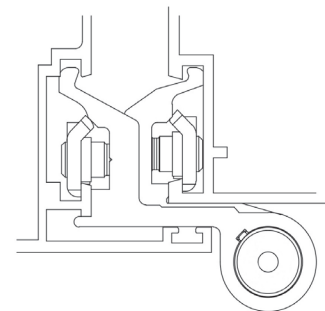
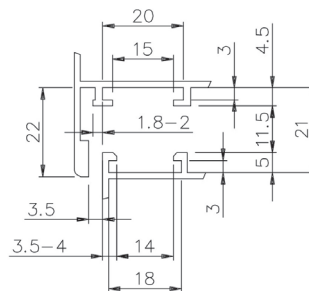
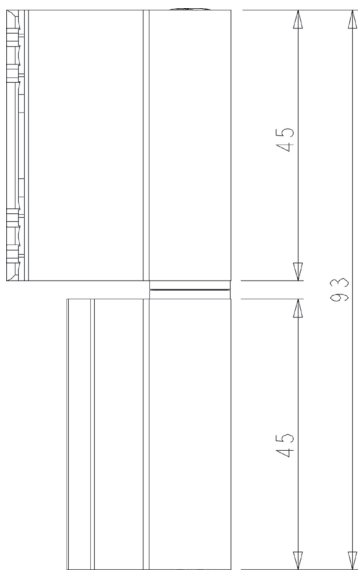
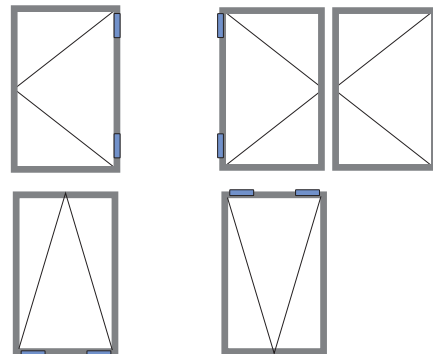

50

AL

ANODIZED

LACQ

2<sup>REG</sup>D

# DOBRADIÇA VULCANA 2P T-SPEC

DOBRADIÇAS

VULCANA

BISAGRA  
HINGE  
PAUMELLE



- Dobradiça em alumínio para perfis em alumínio de canal europeu.  
Recomendada para quando se verificam elevadas forças transversais. Desenvolvida para suportar cargas elevadas. Fiel em inox 304. Os calços apresentam um dentado especial para evitar o deslizamento.
- Bisagra en aluminio para perfiles en aluminio de canal europeo.  
Desarrollada para soportar cargas elevadas. Eje en acero inoxidable 304.  
Las contrachapas presentan un dentado especial para evitar el deslizamiento.
- Aluminium hinge for european groove aluminium profiles.  
Developed for heavy-duty work. Axis in stainless steel 304. Recommended for where there are large transversal forces. The back plates are incorporated with a special serration in order to avoid slipping.
- Paumelle en aluminium pour aluminium profiles de gorge europeenne.  
Recommandée quand il a grands efforts transversaux.  
Developé pour suporté charges élevées. Axe em acier inoxydable 304. Les platines incorporent un denté spécial pour éviter le glissement.

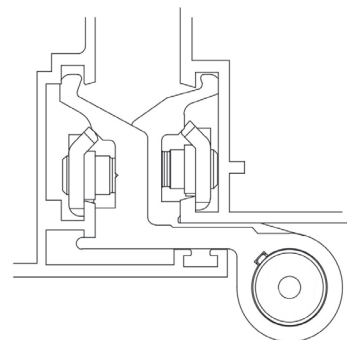
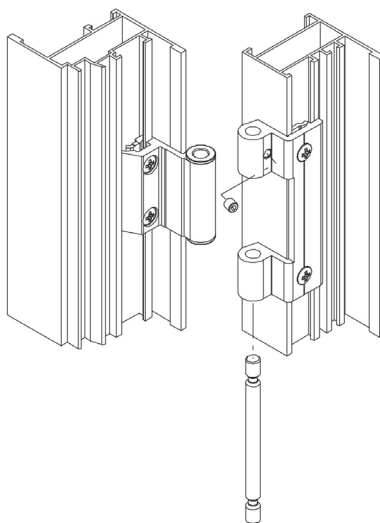
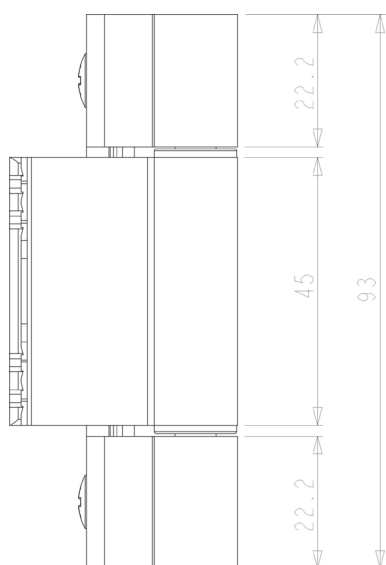
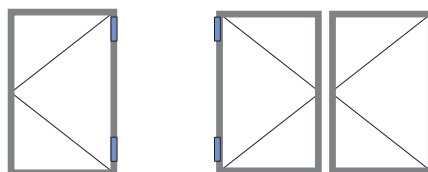

50

AL

ANODIZED

LACQ

## DOBRADIÇAS

# DOBRADIÇA VULCANA 2P T-SPEC 2

BISAGRA  
HINGE  
PAUMELLE

VULCANA



■ Dobradiça em alumínio para perfis em alumínio de canal europeu. Recomendada para quando se verificam forças transversais. Desenvolvida para suportar cargas elevadas. Fiel em inox 304.

■ Bisagra en aluminio para perfiles de canal europeo. Desarrollada para soportar cargas elevadas. Eje en inox 304. Las contrachapas presentan un dentado especial para evitar el deslizamiento.

■ Aluminium hinge for european groove aluminium profiles. Developed for heavy-duty work. 304 stainless steel axis. The back plates are incorporated with a special serration in order to avoid slipping.

■ Paumelle en aluminium profiles de gorge europeenne. Developé pour supporté charges élevées. Axe en acier inoxydable 304. Les platines incorporent un denté spécial pour éviter le glissement.

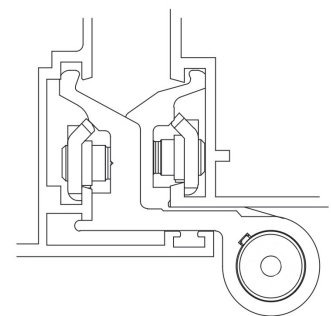
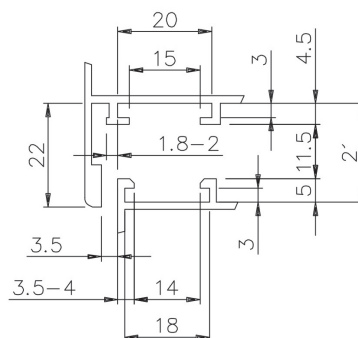
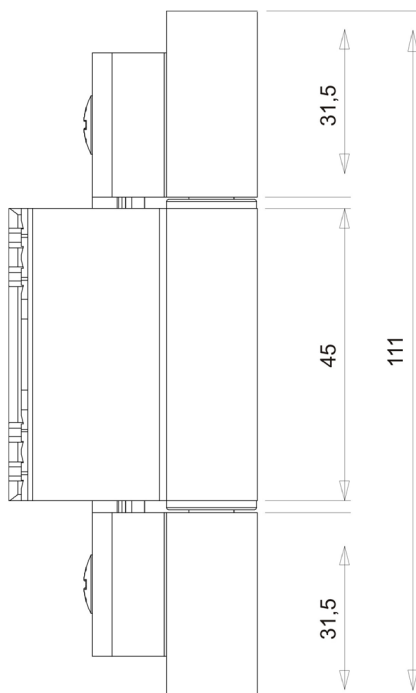
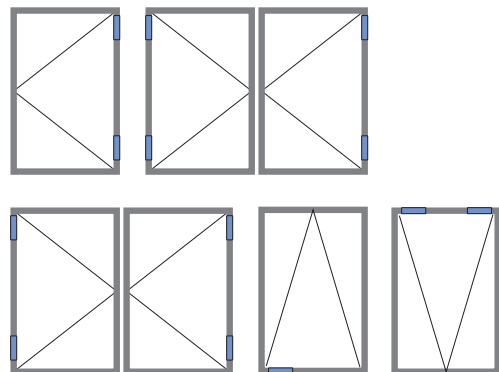



VULCANA

# DOBRADIÇA VULCANA 3P

BISAGRA  
HINGE  
PAUMELLE



- Dobradiça em alumínio para perfis em alumínio de canal europeu. Com regulação e fiel em Inox. Os calços apresentam um dentado especial para evitar o deslizamento.
- Bisagra en aluminio para perfiles en aluminio de canal europeo. Regulable y con eje en acero inoxidable. Las contrachapas presentan un dentado especial para evitar el deslizamiento.
- Aluminium hinge for european groove aluminium profiles. With regulation and stainless steel axis. The back plates are incorporated with a special serration in order to avoid slipping.
- Paumelle en aluminium profiles de gorge europeenne. Réglable et avec axe en acier inoxydable. Les platines incorporent un denté spécil pour éviter le glissement.

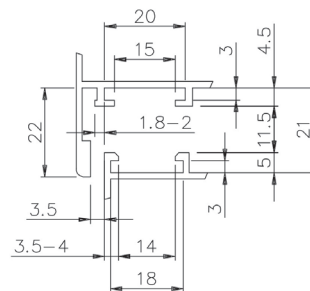
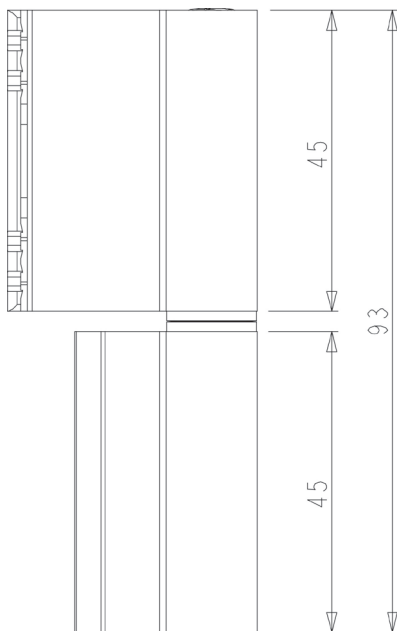
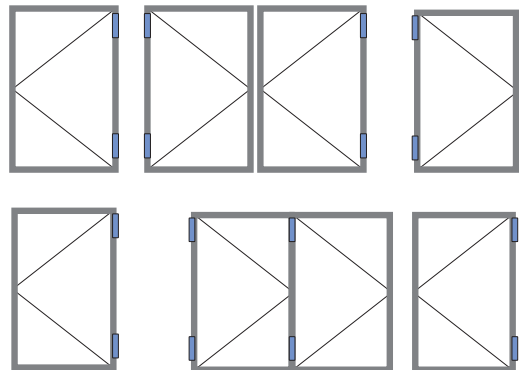

50

AL

ANODIZED

LACQ

REG  
2 D

## DOBRADIÇAS

# DOBRADIÇA VULCANA 3P T-SPEC

BISAGRA  
HINGE  
PAUMELLE

VULCANA<sup>®</sup>



■ Dobradiça em alumínio para perfis de canal europeu. Recomendada para quando se verificam elevadas forças transversais. Fiel em inox 304. Os calços apresentam um dentado especial para evitar o deslizamento.

■ Bisagra en aluminio para perfiles de canal europeo. Desarrollada para soportar cargas elevadas. Eje en inox 304. Las contrachapas presentan un dentado especial para evitar el deslizamiento.

■ Aluminium hinge for european groove aluminium profiles. Developed for heavy-duty work. Axis in stainless steel 304. Recommended for where there are large transversal forces. The back plates are incorporated with a special serration in order to avoid slipping.

■ Paumelle en aluminium profiles de gorge europeenne. Recommandée quand il a grands efforts transversaux. Développé pour supporté charges élevées. Axe en acier inoxydable. Les platines incorporent un denté spécial pour éviter le glissement.

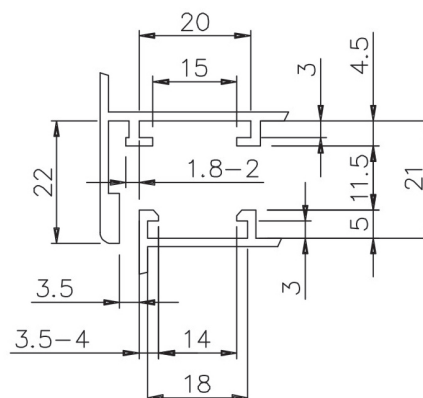
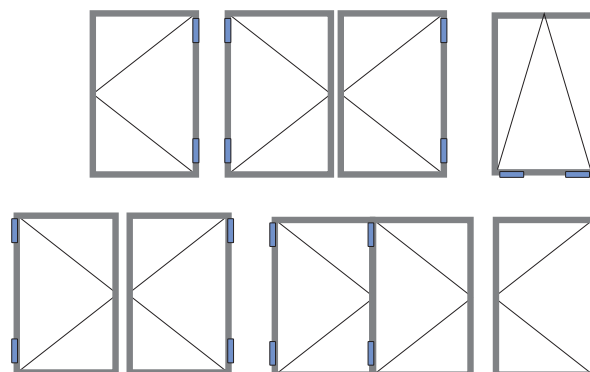
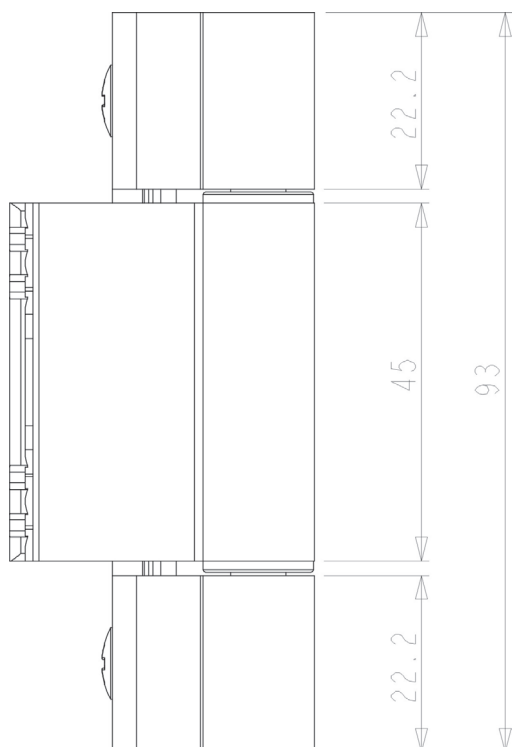

# DOBRADIÇA VULCANA 3P SPEC

BISAGRA  
HINGE  
PAUMELLE

VULCANA



■ Dobradiça em alumínio para perfis em alumínio de canal europeu. Desenvolvida para suportar cargas elevadas. Fiel em inox 304. Os calços apresentam um dentado especial para evitar o deslizamento.

■ Bisagra en aluminio para perfiles de canal europeo. Desarrollada para soportar cargas elevadas. Eje en inox 304. Las contrachapas presentan un dentado especial para evitar el deslizamiento.

■ Aluminium hinge for european groove aluminium profiles. Developed for heavy-duty-work. Axis in 304 stainless steel. The back plates are incorporated with a special serrations in order to avoid slipping.

■ Paumelle en aluminium pour aluminium gorge europeenne. Developé pour suporté charges elevées. Axe en acier inox 304. Les platines incorporent un denté spécial pour éviter le glissement.

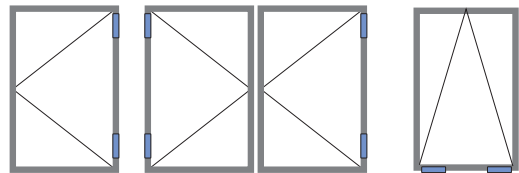

VULCANA 2P SPEC

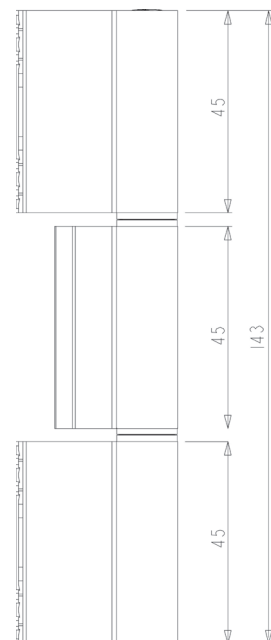
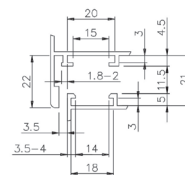
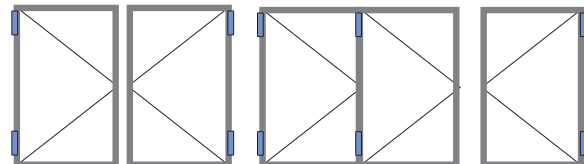

50

AL

ANODIZED

LACQ

REG 2 D

# DOBRADIÇAS

## DOBRADIÇAS SERIE A7

BISAGRAS SERIE A7  
A7 SERIES HINGES  
PAUMELLES SERIE A7

### A7

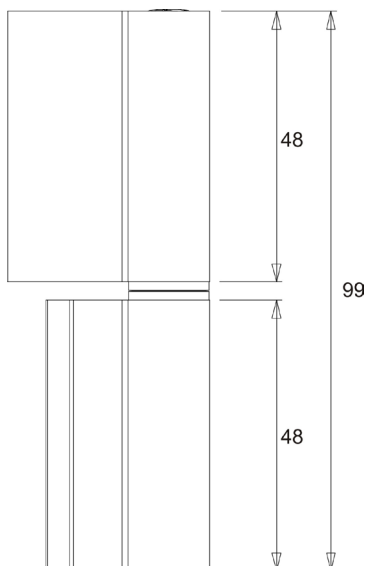

- Dobradiças em alumínio para séries de câmara europeia.  
Fiel em Inox ou em ferro zincado.
- Bisagras en aluminio para series de câmara europea.  
Eje en acero inoxidable o hierro zincado.
- Aluminium hinge for standard european groove profiles  
Stainless steel or zinc steel pin.
- Paumelles en aluminium pour gorge européenne.  
Axe en acier inox ou fer zinguée.

### A7 TRIPLA BALANÇO



### A7 BALANÇO



### A7 TRIPLA



# DOBRADIÇAS VEDA LUZ

BISAGRAS VEDA LUZ  
WINDOW HINGES  
PAUMELLES POUR FENÊTRES

1000

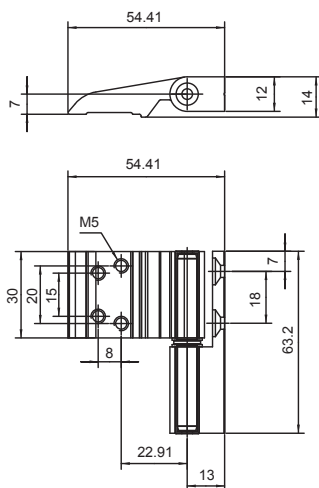

- Dobradiça em alumínio para janelas veda luz.  
Fiel em inox.
- Bisagras en aluminio para ventanas veda luz.  
Fiel em acero inoxidable.
- Aluminium hinge for light brake shutters interior doors.  
Stainless steel axis.
- Paumelles en aluminium.  
Axe en acier inox.

2004

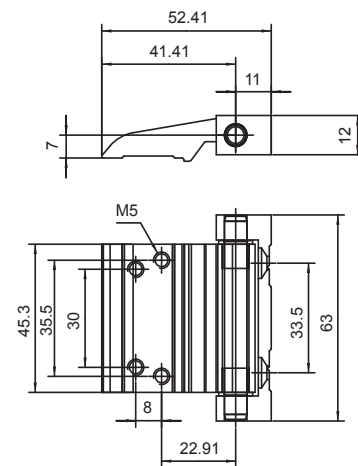

- Dobradiça em alumínio para janelas veda luz.  
Fiel em inox.
- Bisagras en aluminio para ventanas veda luz.  
Fiel em acero inoxidable.
- Aluminium hinge for light brake shutters interior doors.  
Stainless steel axis.
- Paumelles en aluminium.  
Axe en acier inox.



# DOBRADIÇAS DOBRADIÇAS ALUMÍNIO

BISAGRAS ALUMINIO  
ALUMINIUM HINGES  
PAUMELLES EN ALUMINIUM

6000 A6

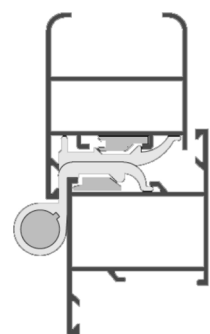
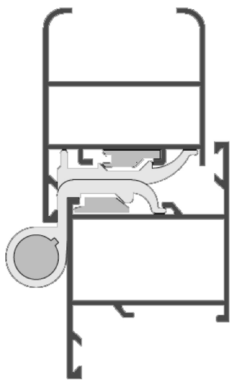

■ Dobradiças alumínio.  
Fiel em Inox ou em ferro zincado.

■ Bisagras aluminio.  
Eje en acero inoxidable o hierro zincado.

■ Aluminium hinges.  
Stainless steel or zinc steel pin.

■ Paumelles aluminium.  
Axe en acier inox ou fer zinguée.

A1

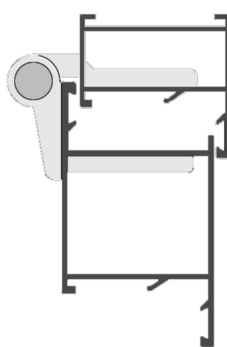
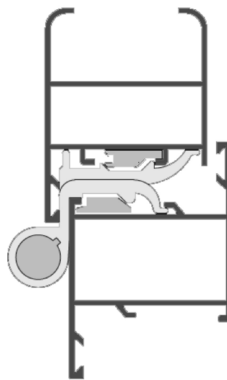

■ Dobradiças de embutir.  
Fiel em Inox ou em ferro zincado.

■ Bisagras de embutir.  
Eje en acero inoxidable o hierro zincado.

■ Insert aluminium hinges.  
Stainless steel or zinc steel pin.

■ Paumelles à encastrier.  
Axe en acier inox ou fer zinguée.

40-20

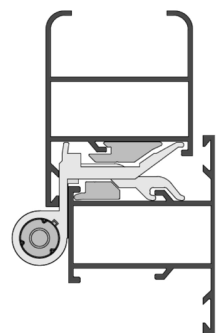
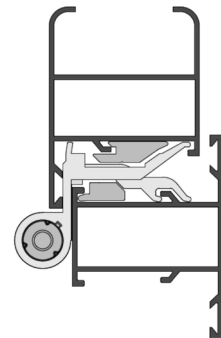

■ Dobradiças de alumínio.  
Fiel em Inox ou em ferro zincado.

■ Bisagras aluminio.  
Eje en acero inoxidable o hierro zincado.

■ Aluminium hinges.  
Stainless steel or zinc steel pin.

■ Paumelles aluminium.  
Axe en acier inox ou fer zinguée.



# DOBRADIÇAS

## ABERTURA BASCULANTE

APERTURA BASCULANTE  
SWINGING OPENING  
OVERTURE BASCULANT

### DOBRADIÇA INVISÍVEL INOX

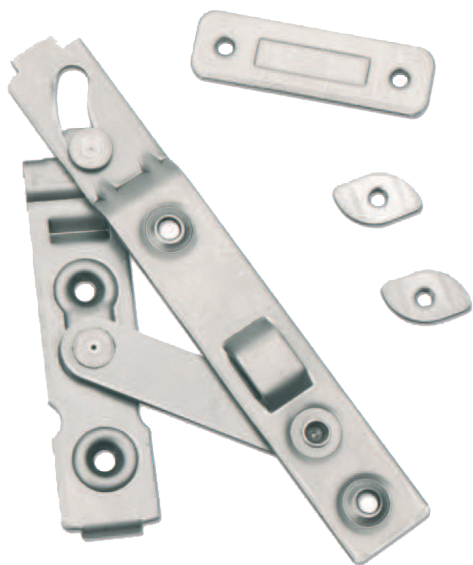

50 INX

- Sistema de abertura basculante en inox 304 para janelas de câmara europeia.  
Funcionando no canal, permanece invisível quando a janela está fechada.
- Sistema de abertura para ventanas basculantes en inox 304 de canal europeu.  
Aplicado en el canal del perfil, continua siendo invisible cuando la ventana está cerrada.
- European chamber tilting system in inox 304 for windows opening system.  
Applied in the chamber, it remains invisible when the window is closed.
- System d'obertura des fenestres basculants de chambre européenne en inox 304.  
Apliqués dans le canal reste invisible lorsque la fenetre est fermé.

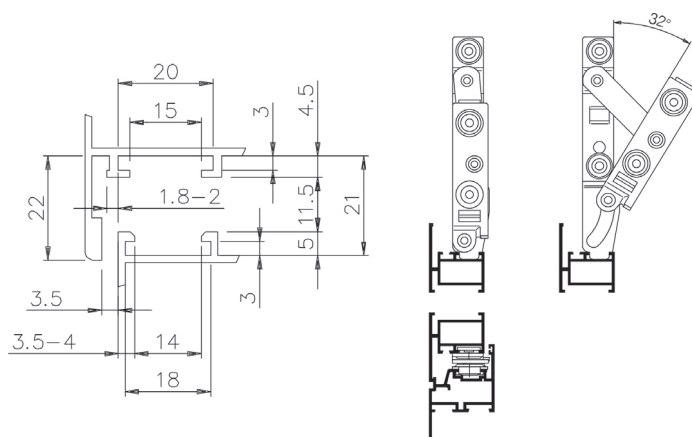

### ENCAIXE BANDEIRA



- Sistema em encaixe bandeira para janelas de abertura basculante interior.
- Sistema de abertura para ventanas basculantes interior.
- Opening system for tilting interior windows.
- Système d'obertura des fenestres basculants intérieur.

50 AL ANODIZED LACQ











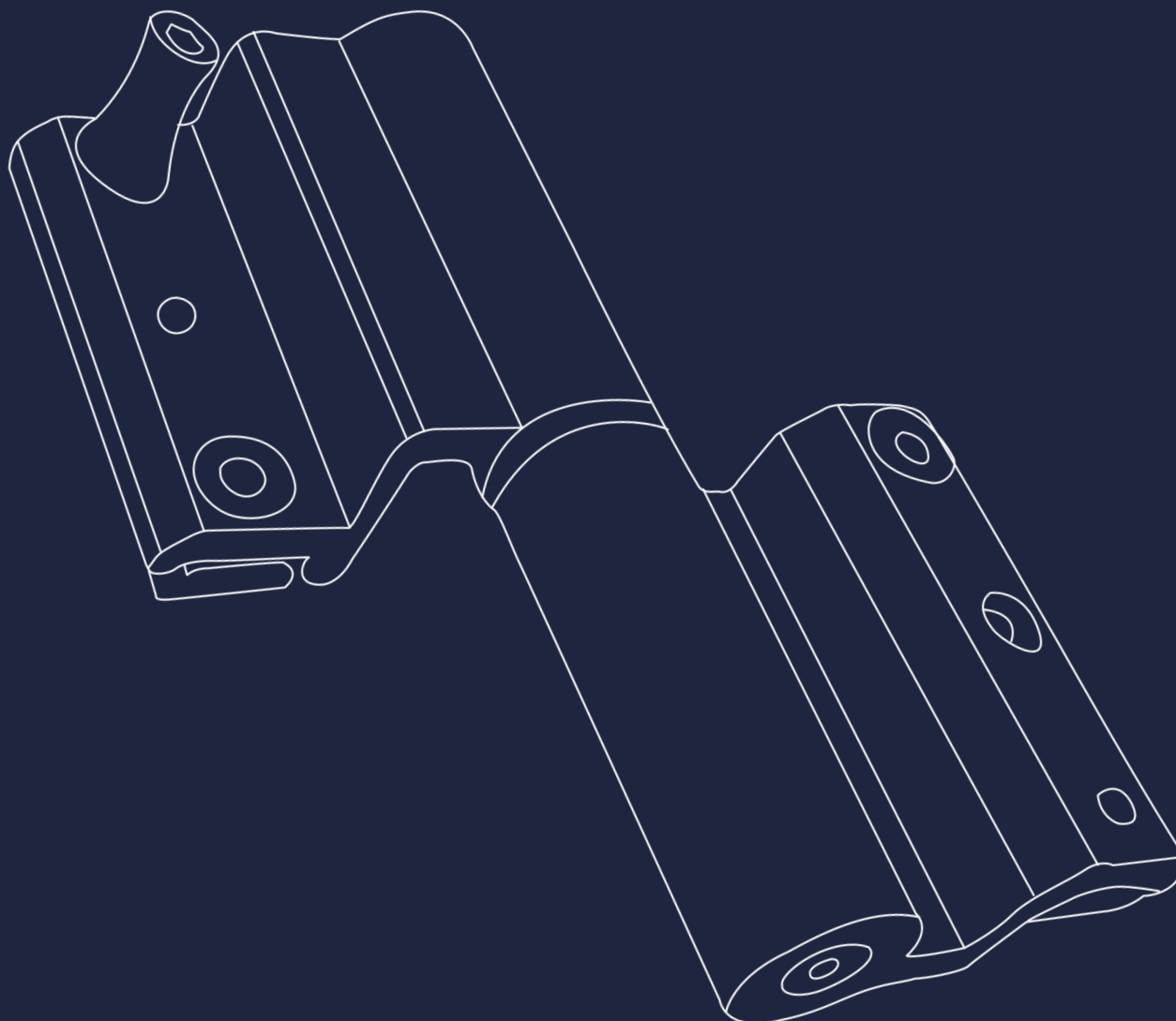

**GNS - Georgina Neto dos Santos, Lda**

E.N.1 - Mourisca do Vouga  
Águeda - Portugal

P.O. Box 3007  
3754-901 Águeda, Portugal

**Geral**  
Telf. +351 234 644 224 / 44 Fax. +351 234 644 842

**Dep. Comercial**  
Telf. +351 234 645 099

[www.ingns.com](http://www.ingns.com)  
[gns@gns.mail.pt](mailto:gns@gns.mail.pt)



**ANCOSI, Lda**

E.N.1 - Mourisca do Vouga  
Águeda - Portugal

P.O. Box 3007  
3754-901 Águeda, Portugal

**Geral**  
Telf. +351 234 645 319 / 44 Fax. +351 234 645 922

[www.ancosi.com](http://www.ancosi.com)  
[ancosi@ancosi.com](mailto:ancosi@ancosi.com)

