



L



---

**SISTEMAS MODULARES  
PARA CABINES  
SANITÁRIAS /**

SANITARY BOOTH  
HARDWARE/  
HERRAJES PARA  
CABINAS SANITÁRIAS.

---

## SISTEMAS MODULARES PARA CABINES SANITÁRIAS / SANITARY BOOTH HARDWARE / HERRAJES PARA CABINAS SANITÁRIAS.

A JNF tem uma gama completa de ferragens em Aço Inox para construção de módulos sanitários ou gabinetes em painéis fenólicos. As ferragens são fabricadas em Aço Inox EN 1.4301 e EN 1.4401, no acabamento escovado e em alguns casos mais específicos têm um revestimento superficial de titânio.

Toda a ferragem é aplicável a painéis com 13 ou 10 mm de espessura. Os tubos estruturais são de diâmetro 19 e 25 mm.

JNF have a full range of fittings in stainless steel for construction of sanitary modules in phenolic panels. The fittings are made in stainless steel EN 1.4301 and EN 1.4401, satin finish and in some specific cases have a titanium coating.

All hardware is applicable to panels with 13 or 10 mm thick. Structural tubes are 19 and 25 mm diameter.

JNF tiene una gama completa de accesorios en acero inoxidable para la construcción de módulos sanitarios en paneles fenólicos. Los accesorios son hechos en acero inoxidable EN 1.4301 y EN 1.4401, acabado satin y, en algunos casos específicos tienen un recubrimiento de titanio.

Todas las herrajes son aplicables a los paneles con 13 o 10 mm de espesor. Tubos estructurales son de 19 y 25 mm de diámetro.

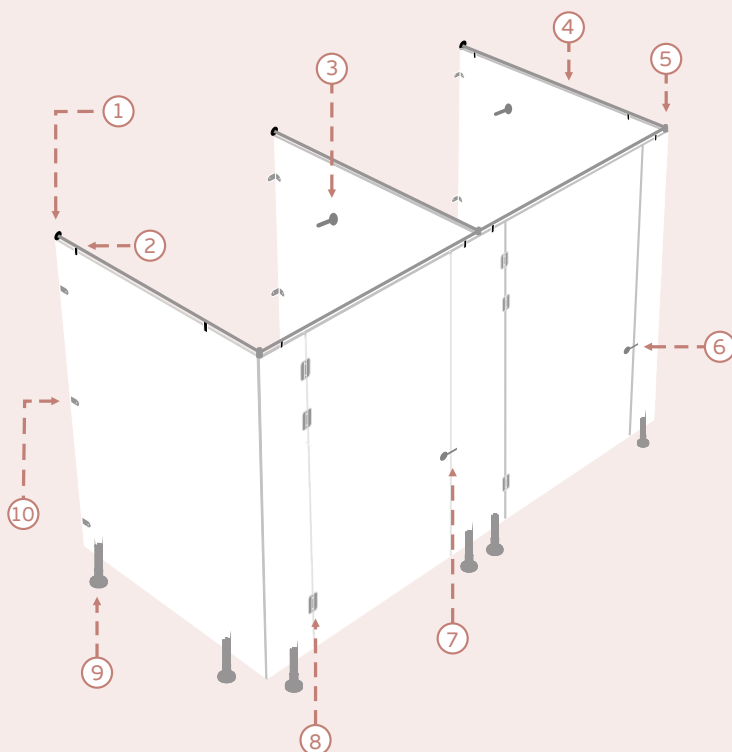

EXEMPLO DE UTILIZAÇÃO DAS  
FERRAGENS PARA MÓDULOS  
SANITÁRIOS /

APPLICATION EXAMPLE OF THE  
SANITARY HARDWARE /

EJEMPLO DE APLICACIÓN DE  
LAS HERRAJES PARA CABINAS  
SANITÁRIAS.

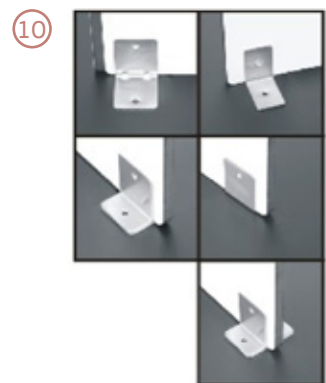
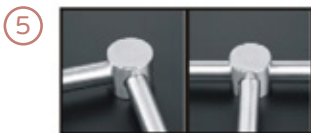
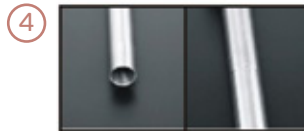
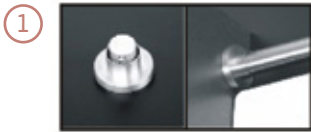

# SISTEMAS MODULARES PARA CABINES SANITÁRIAS / SANITARY BOOTH HARDWARE / HERRAJES PARA CABINAS SANITÁRIAS.



**Também disponível na versão: /**  
 Also available in version: /  
 También disponible en la versión:  
**EN 1.4372**

**ECO series**

## SM.005.A

**Dobradiça. Direita ou esquerda /**  
 Lift off hinge. Right or left hand /  
 Bisagra. Derecha o izquierda.

**EN 1.4301** Satinado / Satin / Satin

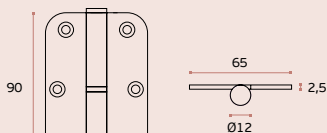

## SM.005.B

**Dobradiça /**  
 Hinge /  
 Bisagra.

**EN 1.4301** Satinado / Satin / Satin

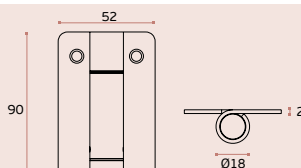

## SM.005.C

**Dobradiça com mola /**  
 Hinge with spring /  
 Bisagra con muelle.

**EN 1.4301** Satinado / Satin / Satin

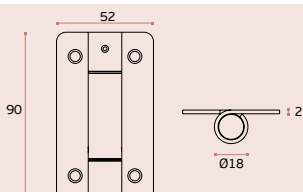

## SM.005.D

**Dobradiça /**  
 Hinge /  
 Bisagra.

**EN 1.4301** Satinado / Satin / Satin

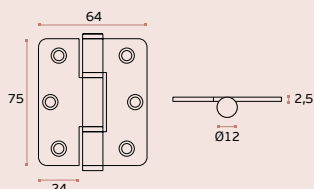

**Também disponível na versão: /**  
 Also available in version: /  
 También disponible en la versión:  
**EN 1.4372**

**ECO series**



Base para painel fabricada em Aço Inox EN 1.4401 e EN 1.4301.

Fixação ao solo através de uma sólida base metálica. O ajuste do suporte em altura é possível mesmo com a base já fixa ao solo e o painel já instalado.

Adjustable foot made in Stainless Steel EN 1.4401 and EN 1.4301.

Fixing on the floor trough a strong metallic base. The height It's adjustable even with the base already fixed on the floor and the panel on the support.

Pie regulable fabricado en Acero Inox EN 1.4401 y EN 1.4301.

Sujecion al suelo a través de solida base metálica. El ajuste es posible mismo despues de la sujecion de la base al suelo y del panel en al soporte.

### SM.017

Base regulável para painel /  
Adjustable foot /  
Pie regulable.

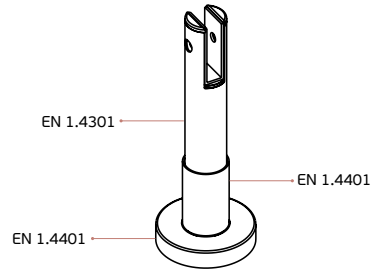
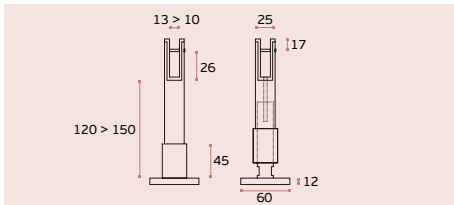

Base para painel fabricada em Aço Inox EN 1.4401 e EN 1.4301.

Fixação ao solo através de uma sólida base metálica. O ajuste do suporte em altura é possível mesmo com a base já fixa ao solo e o painel já instalado.

Adjustable foot made in Stainless Steel EN 1.4401 and EN 1.4301.

Fixing on the floor trough a strong metallic base. The height It's adjustable even with the base already fixed on the floor and the panel on the support.

Pie regulable fabricado en Acero Inox EN 1.4401 y EN 1.4301.

Sujecion al suelo a través de solida base metálica. El ajuste es posible mismo despues de la sujecion de la base al suelo y del panel en al soporte.

### SM.017.XL

Base regulável para painel /  
Adjustable foot /  
Pie regulable.

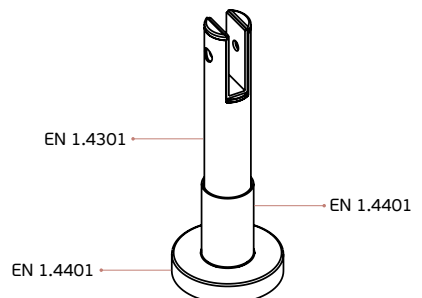
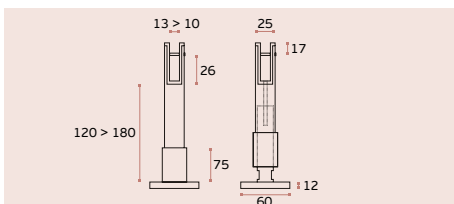

# SISTEMAS MODULARES PARA CABINES SANITÁRIAS / SANITARY BOOTH HARDWARE / HERRAJES PARA CABINAS SANITÁRIAS.



Base para painel fabricada em Aço Inox EN 1.4301 revestido a Titânio, elevadíssima resistência à abrasão e corrosão. Fixação ao solo através de uma sólida base metálica.

Adjustable foot made in Stainless Steel EN 1.4301 Titanium coating, very high resistance to the abrasion and corrosion. Fixing on the floor trough a strong metallic base.

Pie regulable fabricado en Acero Inox EN 1.4301 revestido a Titano, altíssima resistencia a la abrasion y corrosion. Sujecion al suelo atraves de solida base metalica.

## SM.025.T

Base regulável para painel /  
Adjustable foot /  
Pie regulable.

## TITANIUM

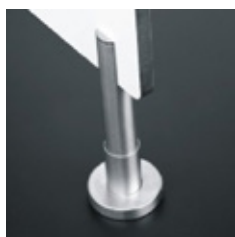
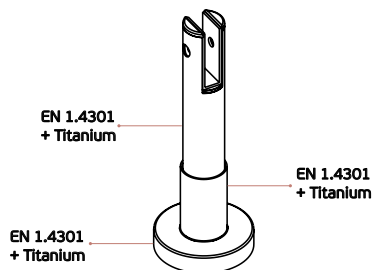
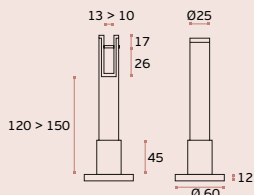

Base para painel fabricada em Aço Inox EN 1.4372. Fixação ao solo através de uma sólida base metálica.

Adjustable foot made in Stainless Steel EN 1.4372. Fixing on the floor trough a strong metallic base.

Pie regulable fabricado en Acero Inox EN 1.4372. Sujecion al suelo atraves de solida base metalica.

## SM.025

Base regulável para painel /  
Adjustable foot /  
Pie regulable.

## ECO series

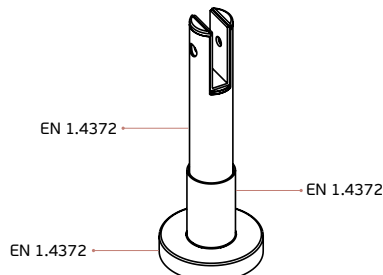
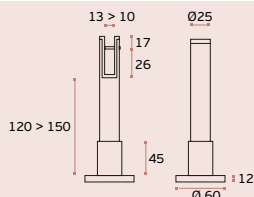

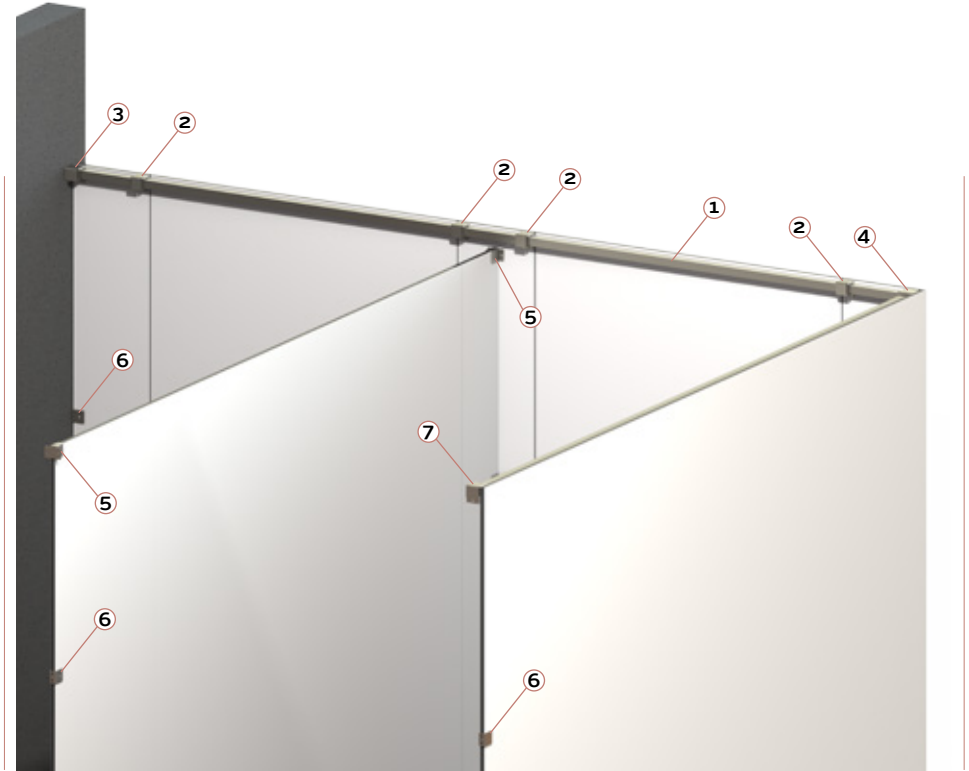



# SISTEMAS MODULARES PARA CABINES SANITÁRIAS / SANITARY BOOTH HARDWARE / HERRAJES PARA CABINAS SANITÁRIAS.

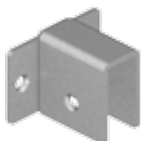

NEW

**SM.061**

**Suporte para painel /**  
 Panel holder /  
 Soporte para panel.

EN 1.4301 Satinado / Satin / Satin

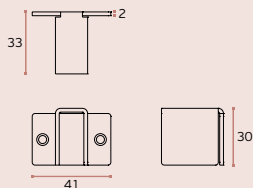

NEW

**SM.062**

**Suporte superior para painel - 90° /**  
 Upper panel holder - 90° /  
 Soporte superior para panel - 90°.

EN 1.4301 Satinado / Satin / Satin

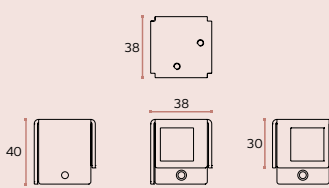

NEW

**SM.063**

**Suporte superior para painel /**  
 Upper panel holder /  
 Soporte superior para panel.

EN 1.4301 Satinado / Satin / Satin

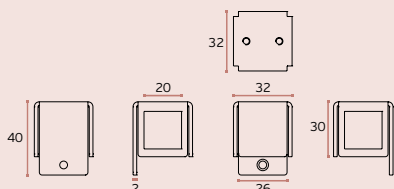

NEW

**SM.064.D**

**Suporte superior para painel /**  
 Upper panel holder /  
 Soporte superior para panel.

EN 1.4301 Satinado / Satin / Satin

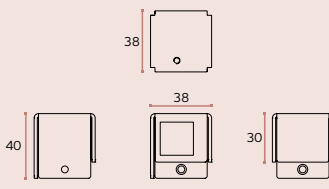

NEW

**SM.064.E**



NEW

### SM.065

Suporte para painel /  
Panel holder /  
Soporte para panel.

EN 1.4301 Satinado / Satin / Satin

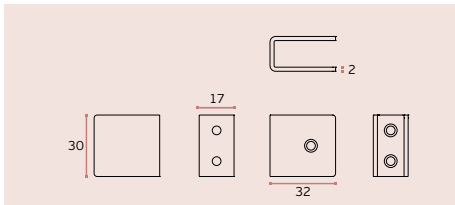

NEW

### SM.010.Q.20

Tubo quadrado - 20x20mm / 3000mm  
Square tube - 20x20mm / 3000mm  
Tubo cuadrado - 20x20mm/3000mm

EN 1.4301 Satinado / Satin / Satin

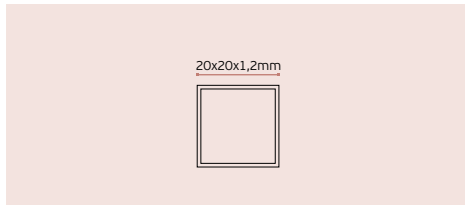

NEW

### SM.070

Suporte para painel /  
Panel holder /  
Soporte para panel.

EN 1.4301 Satinado /  
Satin / Satin

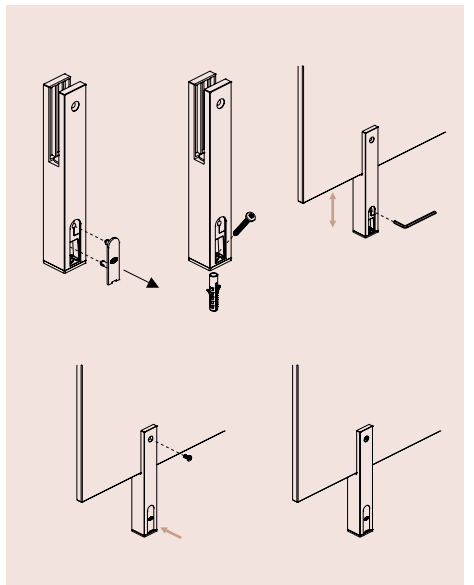
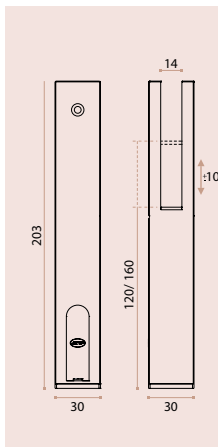

# SISTEMAS MODULARES PARA CABINES SANITÁRIAS / SANITARY BOOTH HARDWARE / HERRAJES PARA CABINAS SANITÁRIAS.



## SM.002

Suporte superior para painel /  
 Upper panel holder /  
 Soporte superior para panel.

EN 1.4301 Satinado / Satin / Satin

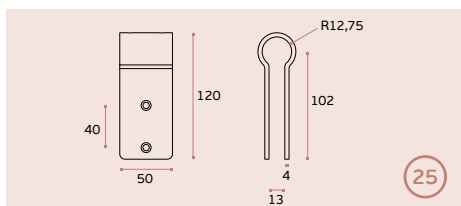

## SM.002.ECO

Suporte superior para painel /  
 Upper panel holder /  
 Soporte superior para panel.

EN 1.4372 Satinado / Satin / Satin

**ECO**  
 series

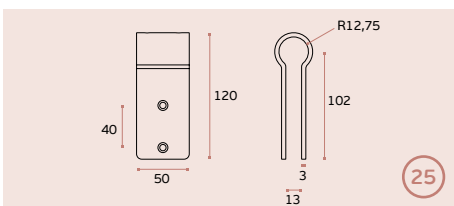

## SM.002.19

Suporte superior para painel /  
 Upper panel holder /  
 Soporte superior para panel.

EN 1.4301 Satinado / Satin / Satin

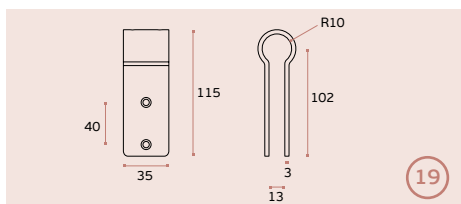

## SM.012.90

Suporte superior para painel /  
 Upper panel holder /  
 Soporte superior para panel.

EN 1.4301 Satinado / Satin / Satin



## SM.012.180

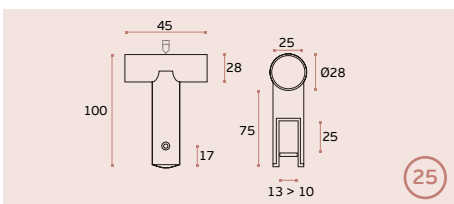



**SM.022**

**Suporte superior para painel /**  
Upper panel holder /  
Soporte superior para panel.  
**EN 1.4301** Satinado / Satin / Satin

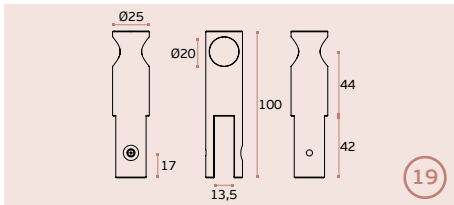

19

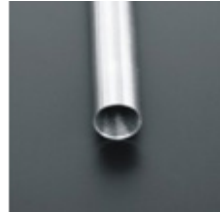

**SM.010.A-019**

**Tubo / Tube / Tubo.**  
**EN 1.4301 -**  
Satinado / Satin / Satin.

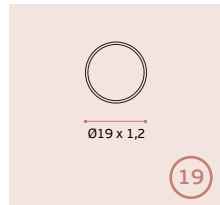

19

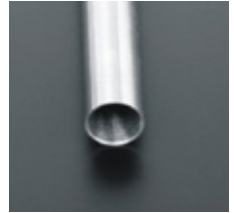

**SM.010.A-025**

**Tubo / Tube / Tubo.**  
**EN 1.4301 -**  
Satinado / Satin / Satin.

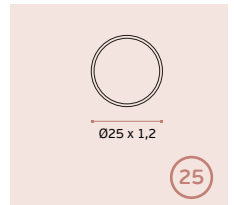

25

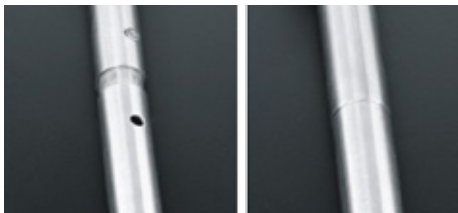

**SM.010C - 019**

**SM.010C - 025**

**Conector para tubo /**  
Tube connector /  
Conectador de tubo.

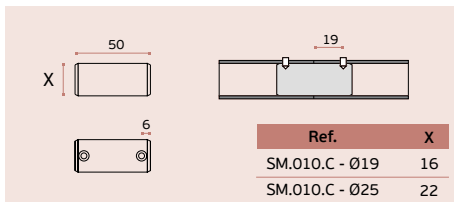

**SM.011.25**

**SM.011.19**

**Suporte de tubo com fixação à parede /**  
Wall mounting tube support /  
Soporte de tubo con sujeción a pared.  
**EN 1.4301** Satinado / Satin / Satin

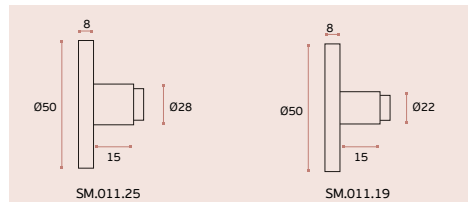

SM.011.25

SM.011.19

# SISTEMAS MODULARES PARA CABINES SANITÁRIAS / SANITARY BOOTH HARDWARE / HERRAJES PARA CABINAS SANITÁRIAS.



## SM.032

**União de tubo a 90° - para tubo Ø25mm/**

Tube connector at 90° - for Ø25mm tube /

Union de tubo a 90° - para tubo Ø25mm.

EN 1.4301 Satinado / Satin / Satin

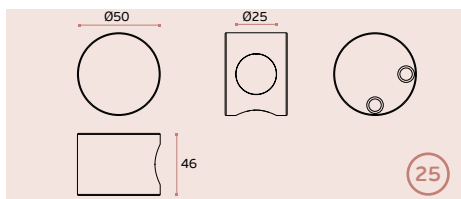

## SM.032.19

**União de tubo a 90° - para tubo Ø19mm/**

Tube connector at 90° - for Ø19mm tube /

Union de tubo a 90° - para tubo Ø19mm.

EN 1.4301 Satinado / Satin / Satin

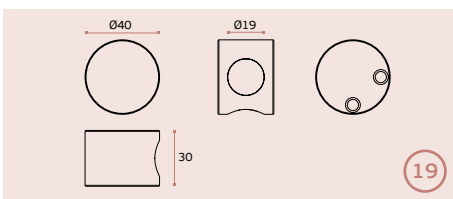

## SM.033

**União de tubo a 90° e 180° - para tubo Ø25mm/**

Tube connector at 90° and 180° - for Ø25mm tube /

Union de tubo a 90° y 180° - para tubo Ø25mm.

EN 1.4301 Satinado / Satin / Satin

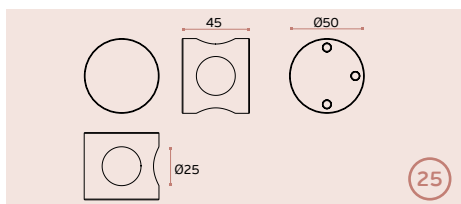

## SM.033.19

**União de tubo a 90° e 180° - para tubo Ø19mm/**

Tube connector at 90° and 180° - for Ø19mm tube /

Union de tubo a 90° y 180° - para tubo Ø19mm.

EN 1.4301 Satinado / Satin / Satin

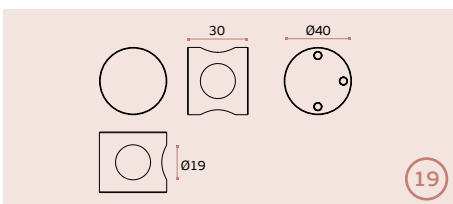



**SM.040**

**Parafuso de ligação para acessórios de fenólico /**  
Screw connection for phenolic accessories /  
Tornillo pasante de conexión para accesorios de fenolico.

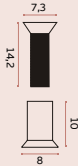

**SM.042.**

**Parafuso de ligação para acessórios de fenólico /**  
Screw connection for phenolic accessories /  
Tornillo pasante de conexión para accesorios de fenolico.

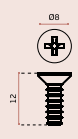

SM.042.A



SM.042.B



**SM.015**

**União de tubo a 90° - para tubo Ø25mm /**  
Tube connector at 90° - for Ø25mm tube /  
Union de tubo a 90° - para tubo Ø25mm.

**EN 1.4301** Satinado / Satin / Satin

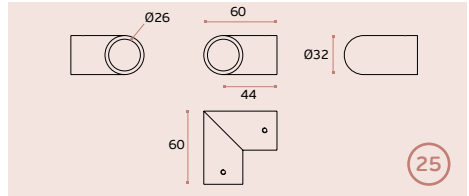

25



**SM.050**

**Fecho para wc com indicador "livre-ocupado" /**  
Bathroom latch with indicator /  
Cierre de baño con indicador.

**EN 1.4372** Satinado / Satin / Satin

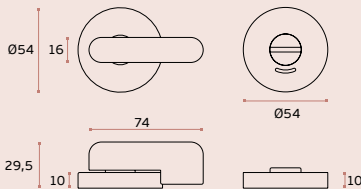

**INTERIOR**

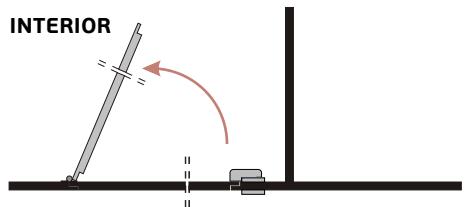

**EXTERIOR**

**INTERIOR**

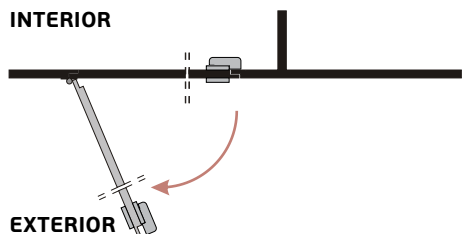

**EXTERIOR**

# SISTEMAS MODULARES PARA CABINES SANITÁRIAS / SANITARY BOOTH HARDWARE / HERRAJES PARA CABINAS SANITÁRIAS.

## EASY FIX



### SM.031

#### Fecho com indicador "livre-ocupado" /

Bathroom latch with indicator /

Cierre de baño con indicador.

EN 1.4301 Satinado / Satin / Satin

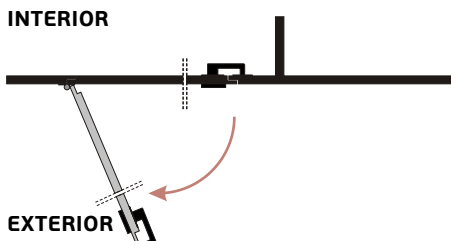
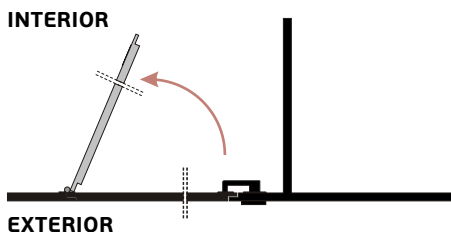
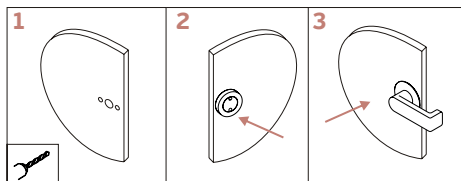

## MODELO PATENTEADO / PATENTED MODEL / MODELO PATENTADO

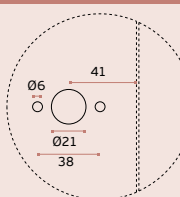
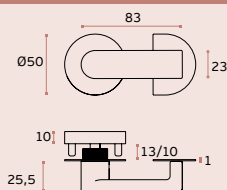

**Furação para painel fenólico /**  
 Drilling for phenolic panel /  
 Talladro para panel fenólico.

### 1- Botão de fecho com sistema de montagem rápida /

Locking button with quick assembling system /  
 Botón de bloqueo con sistema de montaje rápido.

### 2- Anilha anti-fricção / Anti friction washer /

Arandella anti fricción.

### 3- Espelho em aço inox / Stainless steel cover /

Roseta en acero inox.

### 4- Indicador livre/ocupado, pode ser optado na instalação /

Indicator for snib indicator, can be chosen on installation /  
 Indicador de cierre baño, opcional en la instalación.

### 5- chave para desbloqueio / Unlocking key /

Llave de desbloqueo

### 6- Fecho exterior / Outside Lock / Cierre exterior.

### 7- Chapa testa em Aço inox EN 1.4301 /

Strike plate made in Stainless

steel EN 1.4301 / Cerradero en Acero Inox EN 1.4301

### 8- Chave para remoção do botão / Key to remove the

button / Llave para quitar el botón.

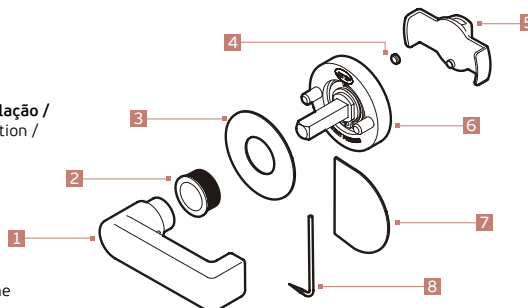



**SM.035**

Material: EN 1.4301  
Satinado / Satin / Satin  
Fecho / Bolt / Pasador.

**SM.035.P**

Polido / Polished / Pulido

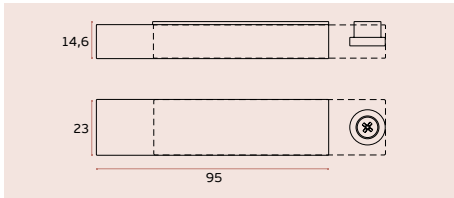
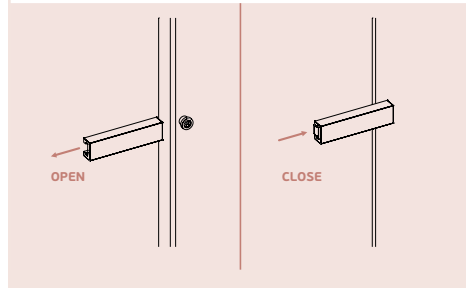
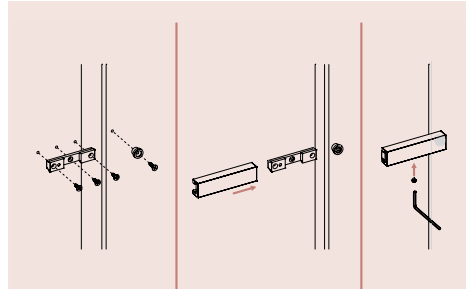

NEW

**SM.060**

Fecho com indicador "livre-ocupado" /  
Bathroom latch with indicator /  
Cierre de baño con indicador.

EN 1.4301 Satinado / Satin / Satin

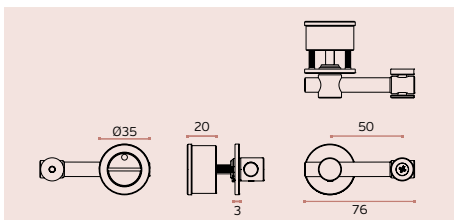
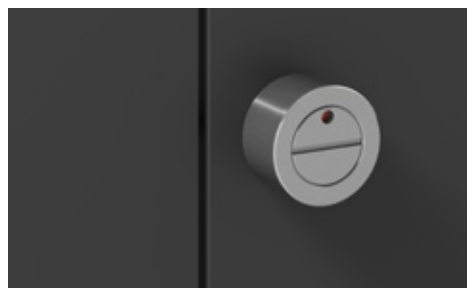
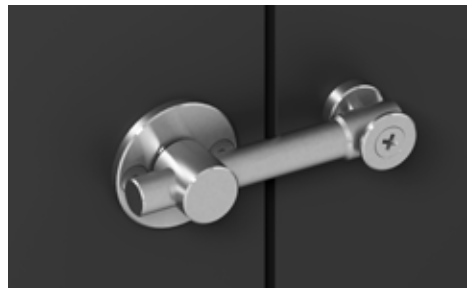



# SISTEMAS MODULARES PARA CABINES SANITÁRIAS / SANITARY BOOTH HARDWARE / HERRAJES PARA CABINAS SANITÁRIAS.

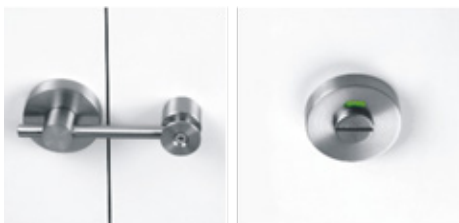

## SM.026

### Fecho com indicador "livre-ocupado" /

Bathroom latch with indicator /

Cierre de baño con indicador.

EN 1.4301 Satinado / Satin / Satin

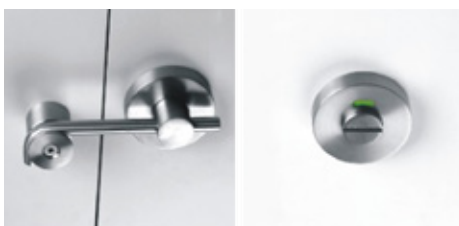
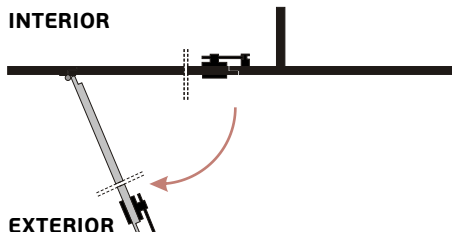
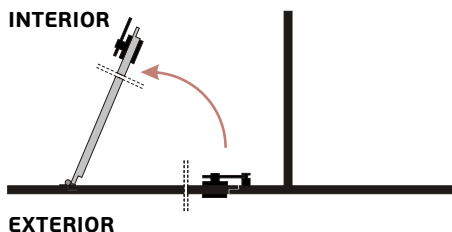
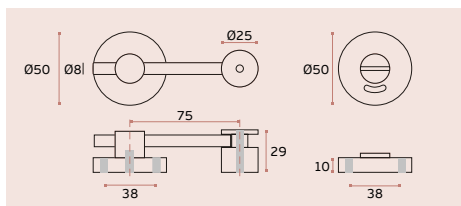

## SM.027

### Fecho para wc com indicador "livre-ocupado" para portas de correr /

Bathroom latch for sliding door with indicator /

Cierre de baño para puertas correderas con indicador.

EN 1.4301 Satinado / Satin / Satin

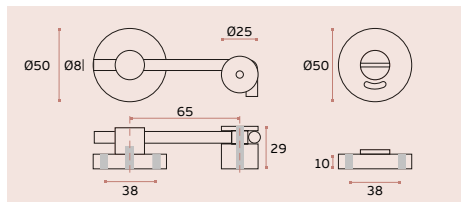

NEW

## IN.17.616

Material: EN 1.4301

Satinado / Satin / Satin

Fecho com indicador de cor /

Slide bolt with color indicator /

Cierre con indicador de color

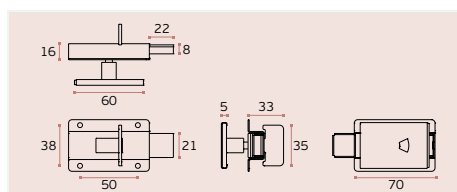



**SM.029**

**Fecho com indicador "livre-ocupado" /**  
Bathroom latch with indicator /  
Cierre de baño con indicador.

**EN 1.4301** Satinado / Satin / Satin

**IN.04.251**  
**Chave triangular /**  
Triangular key /  
Llave triangular.

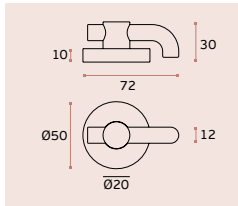

**INTERIOR**

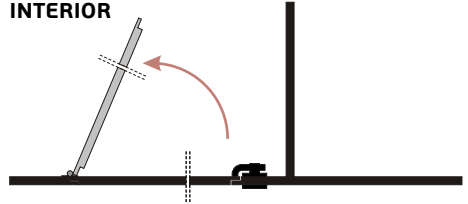

**EXTERIOR**

**INTERIOR**

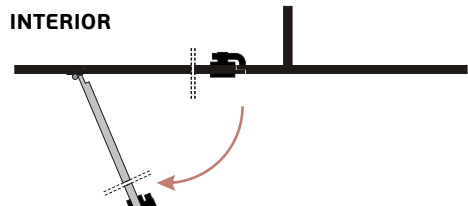

**EXTERIOR**



**SM.030**

**Fecho para wc com indicador "livre-ocupado" /**  
Bathroom latch with indicator /  
Cierre de baño con indicador.

**EN 1.4301** Satinado / Satin / Satin

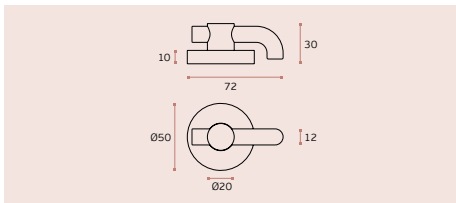

**INTERIOR**

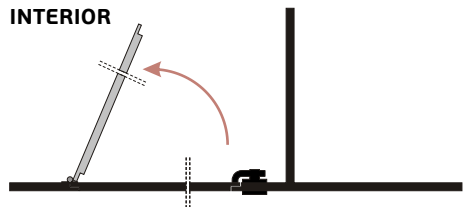

**EXTERIOR**

**INTERIOR**

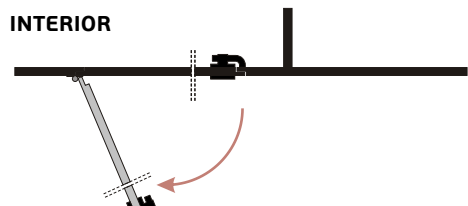

**EXTERIOR**

# SISTEMAS MODULARES PARA CABINES SANITÁRIAS / SANITARY BOOTH HARDWARE / HERRAJES PARA CABINAS SANITÁRIAS.



## SM.02039

**Fecho com indicador "livre-ocupado" /**  
Bathroom latch with indicator /  
Cierre de baño con indicador.

**Liga de Zinco Cor inox / Zinc alloy inox color /**  
Zamak color inox.

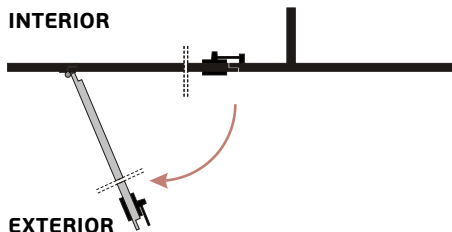
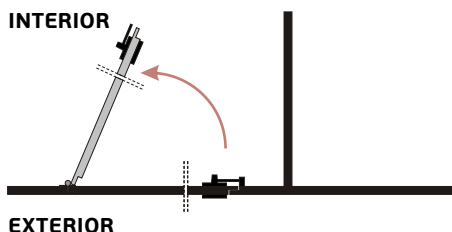
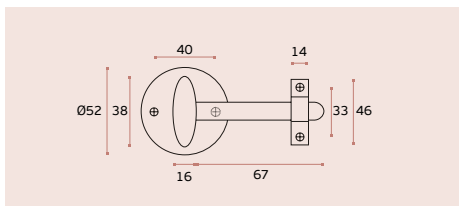

## SM.004

**Suporte para painel /**  
Panel holder /  
Soporte para panel.

**EN 1.4301 Satinado / Satin / Satin**

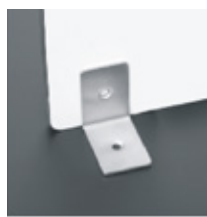
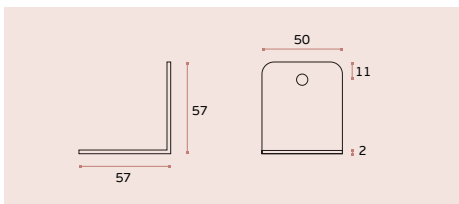

## SM.044

**Suporte para painel /**  
Panel holder /  
Soporte para panel.

**EN 1.4301 Satinado / Satin / Satin**

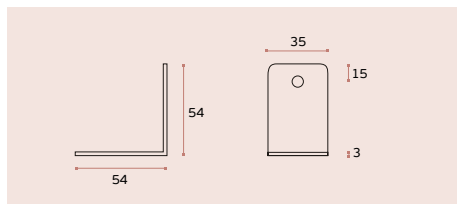



**SM.014**

Suporte para painel /  
Panel holder /  
Soporte para panel.

EN 1.4301 Satinado / Satin / Satin

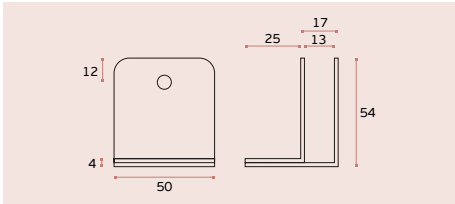

**SM.024**

Suporte para painel /  
Panel holder /  
Soporte para panel.

EN 1.4301 Satinado / Satin / Satin

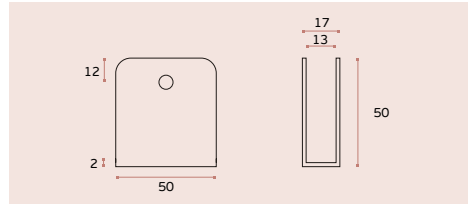

**SM.034**

Suporte para painel /  
Panel holder /  
Soporte para panel.

EN 1.4301 Satinado / Satin / Satin

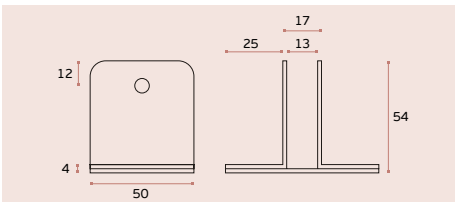

# SISTEMAS MODULARES PARA CABINES SANITÁRIAS / SANITARY BOOTH HARDWARE / HERRAJES PARA CABINAS SANITÁRIAS.

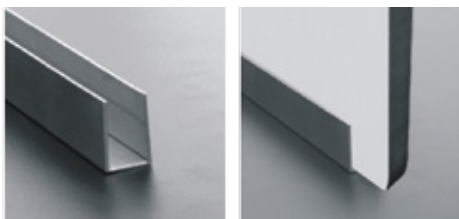

## SM.101

**Perfil em "U" para painel de 13mm /**  
 "U" shape profile for 13mm panel /  
 Perfil en "U" para panel de 13mm.

**EN 1.4301** Satinado / Satin / Satin

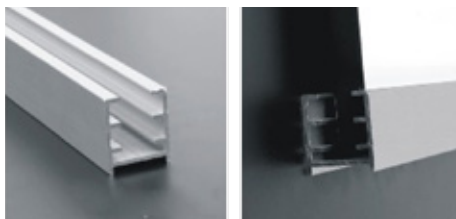

## SM.103

**Perfil para painel de 13mm /**  
 Profile for 13mm panel /  
 Perfil para panel de 13mm.

**Alumínio / Aluminium / Aluminio**

Cor natural / Natural color / Color natural

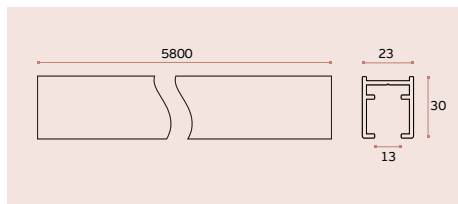
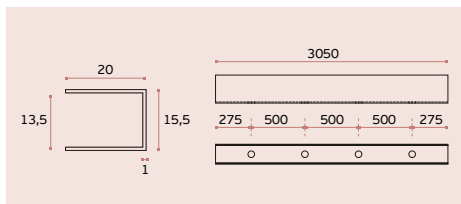

## SM.008

**Cabide / batente de porta anti-vandalismo /**  
 Hook / door stopper concealed fixing /  
 Percha / tope de puerta anti-vandalismo.

**EN 1.4301** Satinado / Satin / Satin



## IN.14.529

**Cabide duplo com batente de porta /**  
 Double hook with door stopper /  
 Colgador doble con tope de puerta.

**EN 1.4301** Satinado / Satin / Satin

**Também disponível na versão: /**  
 Also available in version: /

Also available in version: /

Tambien disponible en la versión:

**EN 1.4372**

**ECO series**

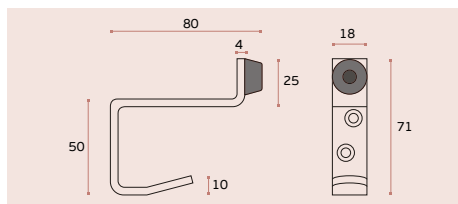
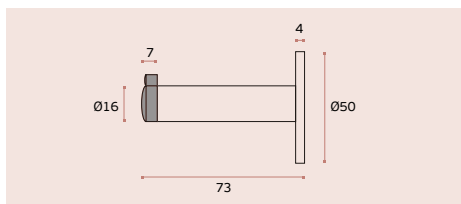



### IN.14.530.ECO

**Cabide duplo /**  
Double hook /  
Colgador doble.

**EN 1.4372** Satinado / Satin / Satin

**ECO**  
series

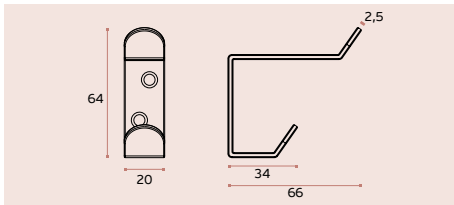

### IN.75.030

**Puxadores para portas de vidro ou fenólico /**  
Knobs for glass or phenolic doors /  
Pomos para puerta de cristal o fenolico.

**Material EN 1.4301** Satinado / Satin / Satin

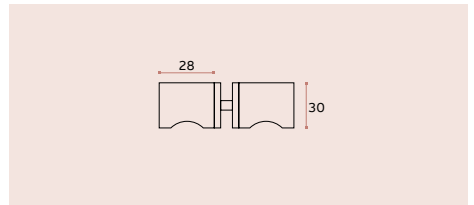

### SM.019

**Puxador de porta duplo, anti-vandalismo /**  
Back to back door knob, anti vandalism fixing /  
Tirador de puerta doble, anti vandalismo.

**EN 1.4301** Satinado / Satin / Satin

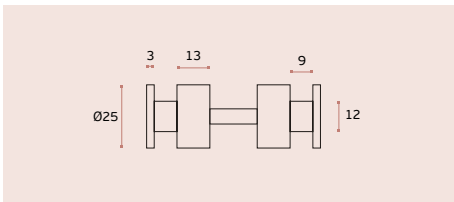

### SM.020

**Puxador de porta duplo, anti-vandalismo /**  
Back to back door knob, anti vandalism fixing /  
Tirador de puerta doble, anti vandalismo.

**EN 1.4372** Satinado / Satin / Satin

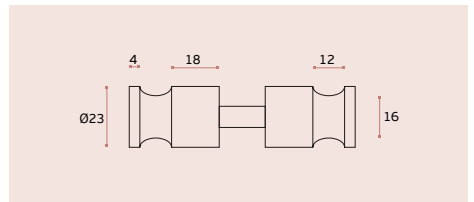

## **SISTEMAS MODULARES PARA CABINES SANITÁRIAS / SANITARY BOOTH HARDWARE / HERRAJES PARA CABINAS SANITÁRIAS.**

**Sistema para cabines sanitárias  
 especialmente desenvolvido  
 para pessoas com mobilidade  
 reduzida.**

**Sistema de porta de correr para  
 painéis fenólicos de 13mm.**

**O sistema de fecho está preparado  
 para utilizadores com mobilidade  
 reduzida, e um sistema de  
 segurança permite desbloquear  
 o fecho pelo exterior em caso de  
 qualquer emergência.**

System for Sanitary cabinets  
 specially designed for disabled  
 people.

Sliding door system for phenolic  
 panels with 13mm.

The lock system is ready for users  
 with reduced mobility, and it's  
 provided with a security system to  
 unlock the system from the outside  
 in case of any emergency.

Sistema para cabinas sanitarias  
 especialmente diseñado para  
 personas con movilidad reducida.

Sistema de puertas correderas de  
 paneles fenólicos con 13mm.

El sistema de cierre está valido para  
 los usuarios con movilidad reducida,  
 tiene un sistema de  
 seguridad para desbloquear el  
 sistema por el exterior en caso de  
 cualquier emergencia.

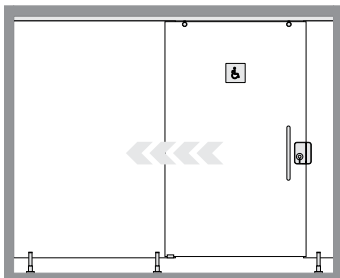

### SM.036

**EN 1.4301** Satinado / Satin  
**Fechadura para portas de correr, para aplicar com fecho livre-ocupado.** Testa para parede incluída/  
Lock for sliding door to use with snib indicator.  
Strike plate included /  
Cerradura para puertas correderas para aplicar con condensa de baño. Cerradero incluido.

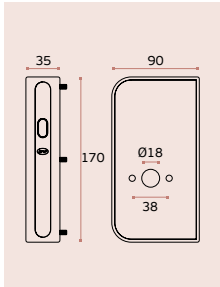

### SM.037

**EN 1.4301** Satinado / Satin  
**Fechadura para portas de correr, para aplicar com cilindro.** Testa para parede incluída/  
Lock for sliding door to use with european cylinder.  
Strike plate included /  
Cerradura para puertas correderas para aplicar con bombillo. Cerradero incluido.

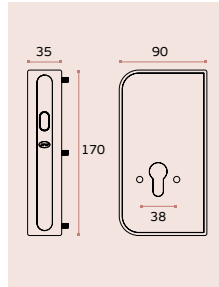

### SM.038

**EN 1.4301** Satinado / Satin  
**Testa para aplicar com SM.036 e SM.037 (não incluída) /**  
Strike plate to use with SM.036 and SM.037 (not included)/  
Cerradero para aplicar con SM.036 y SM.03 (no incluido).

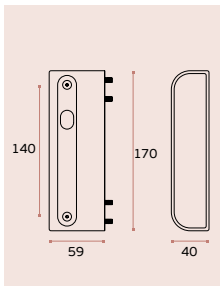

### IN.04.110

**EN 1.4301** Satinado / Satin / Satin  
**Fecho WC com ranhura para moeda /**  
Bathroom snib indicator with coin slot /  
Condensa de banho com fenda para moeda.

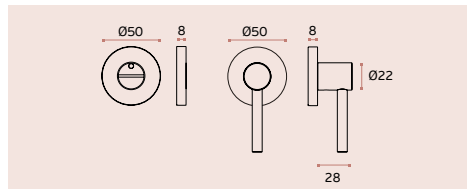



# SISTEMAS MODULARES PARA CABINES SANITÁRIAS / SANITARY BOOTH HARDWARE / HERRAJES PARA CABINAS SANITÁRIAS.

## IN.15.258

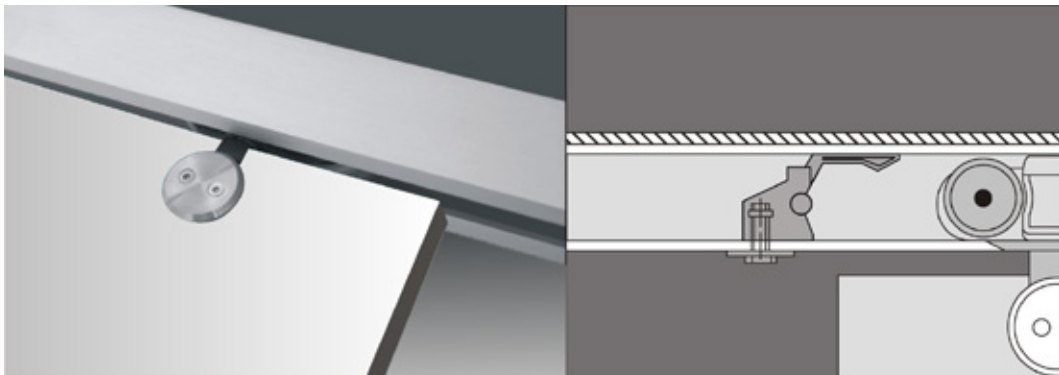

2x- Roldanas com suporte para fenólico /  
 2x- Wheels with phenolic support /  
 2x- Ruedas con soporte para fenolico.

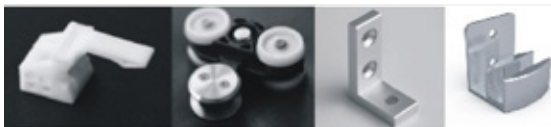

2x- Travões /  
 2x- Stoppers /  
 2x- Frenos.



2x- Suportes de parede /  
 2x- Wall supports /  
 2x- Soportes de pared.



1x- Guia inferior para fenólico /  
 1x- Lower guide to phenolic /  
 1x- Guia de bajo para fenólico.

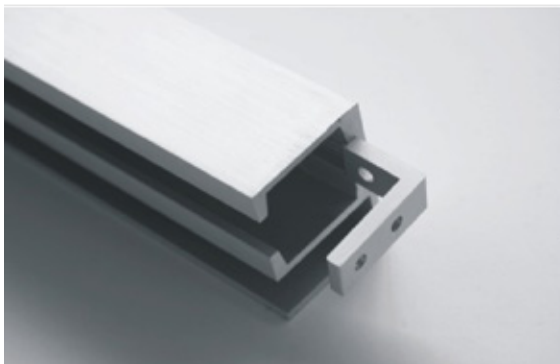

2900mm- Calha de alumínio (pode ser cortada)/  
 2900mm- Aluminium track (can be cutted)/  
 2900mm- Guia en aluminio (puede ser cortada).

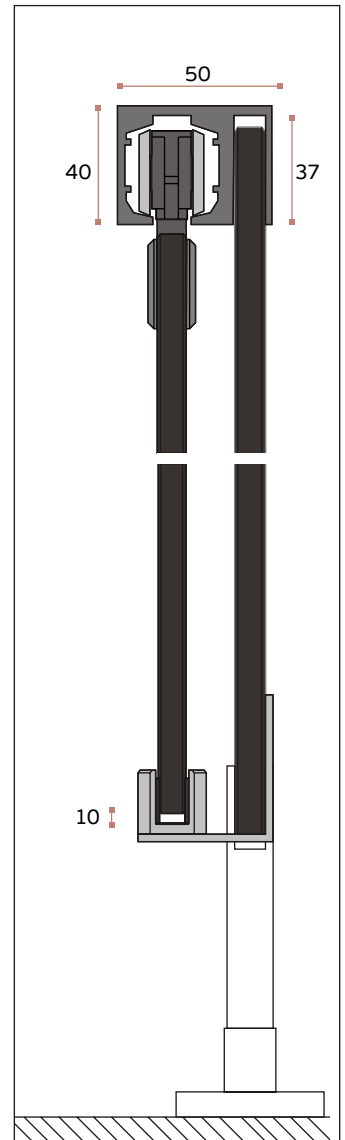
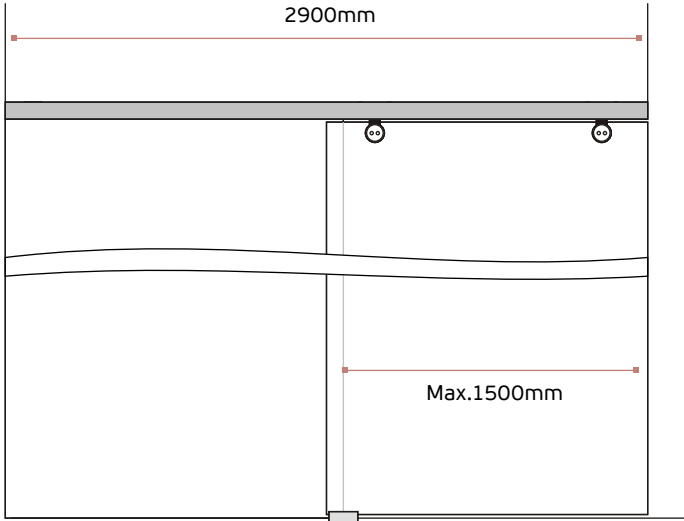

Medidas dos furos a efectuar na porta do fenólico /  
SIZES OF THE HOLES TO BE MADE IN THE PHENOLIC DOOR /  
Medidas de los taladros en la puerta en fenolico.

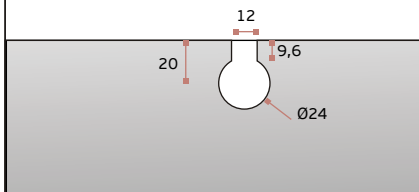

Largura máx. da porta / Max. door length / Anchura max. de la puerta - 1500mm  
Peso máx. da porta / Max. door weight / Peso max. de la puerta - 60Kg  
Espesuras de fenólico / Phenolic thickness / Espesor de lo fenolico - 10-13 mm.